

Controller description

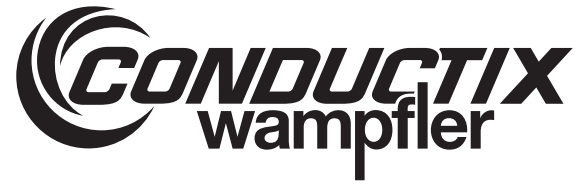

ST-87x

Vehicle controller



Conductix-Wampfler Automation GmbH
Handelshof 16 A
14478 Potsdam
Germany
Telephone: +49 (0) 331 887344-0
Fax: +49 (0) 331 887344-19
Email: info.potsdam@conductix.com
Internet: www.conductix.com
Translation of the original
STB_0004, 10, en_GB

Table of contents

1	Information on the description.....	9
1.1	Revision history.....	9
1.2	How to use and store the description.....	9
1.3	Applicable documents.....	10
1.4	Copyright protection.....	10
1.5	Illustrations.....	10
1.6	Brands.....	10
2	Warranty and liability.....	11
2.1	Warranty.....	11
2.2	Limitation of liability.....	11
3	Safety instructions.....	13
3.1	Warning concept.....	13
3.1.1	Arrangement of warnings.....	13
3.1.2	Structure of warnings.....	13
3.1.3	Signal words.....	14
3.1.4	Hazard symbols.....	14
3.1.5	Suggestions and recommendations.....	15
3.2	Intended use.....	16
3.3	Foreseeable incorrect use.....	16
3.4	Modifications and alterations.....	16
3.5	Responsibility of the operator.....	17
3.6	Personnel and qualifications.....	18
3.7	Special hazards.....	20
3.8	Safety instructions for the system operator and manufacturer....	21
3.9	Safety devices.....	22
3.10	Safe isolation.....	23
4	Product description.....	25
4.1	Series 8.....	25
4.2	87x / 88x series model name.....	25
4.3	87x / 88x series power classes.....	25
4.4	87x / 88x series scope of functions.....	25
4.5	Type label.....	26
4.6	ST-87x / 88x designs.....	27
4.7	Basic device.....	28
5	Transport and storage.....	29
5.1	Transport.....	29

5.2	Transport inspection.....	29
5.3	Storage.....	30
6	Mechanical installation.....	31
6.1	Open spaces and cooling.....	34
6.2	Installation position.....	36
6.3	Installation.....	37
6.3.1	Installation with direct screw connection.....	39
6.3.2	Installation with attachment bracket.....	40
7	Electrical installation.....	43
7.1	Notes about electrical installation.....	46
7.1.1	Residual current circuit breaker and mains fusing.....	46
7.1.2	Electromagnetic compatibility.....	46
7.1.3	EMC installation notes.....	48
7.1.4	Cable routing.....	52
7.1.5	Control system motor output.....	52
7.1.6	Protective measures.....	53
7.2	Connecting the electrical parts of the control system.....	54
7.3	Electrical connections.....	56
7.3.1	Connection overview.....	56
7.3.2	X1 - Supply.....	57
7.3.3	X2 - Motor.....	58
7.3.4	X10 - BLDC motor encoder.....	59
7.3.5	X10 - Brake resistance.....	60
7.3.6	X13 - Sensors.....	60
7.3.7	X14 - Sensors.....	61
7.3.8	X15 - Sensors.....	61
7.3.9	X16 - Sensors.....	62
7.3.10	X17 - Sensors.....	63
7.3.11	X30 - USB.....	64
7.4	Earthing the control system.....	65
8	Commissioning.....	67
8.1	Notes about commissioning.....	70
8.2	Requirements.....	71
8.3	Commissioning procedure.....	72
8.4	Switch on control system.....	73
8.5	Assign control system parameters.....	75
8.5.1	Vehicle parameters and configuration switches.....	76

8.5.1.1	Creating and saving parameters and configuration switches.....	78
8.5.1.2	Transferring parameters and configuration switches.....	79
8.5.2	Vehicle tables – PCM.....	80
8.5.2.1	PCM commands.....	80
8.5.2.2	Speed tables – PCM.....	85
8.5.2.3	Distance table – PCM.....	85
8.5.2.4	Creating and saving vehicle tables.....	86
8.5.2.5	Transferring vehicle tables.....	87
8.5.3	Vehicle tables – Rail bus.....	88
8.5.3.1	Segment table – Rail bus.....	88
8.5.3.2	Speed table – Rail bus.....	90
8.5.3.3	Distance table – Rail bus.....	91
8.5.3.4	Stop-offset table.....	92
8.5.3.5	Creating and saving vehicle tables.....	93
8.5.3.6	Transferring vehicle tables.....	94
8.6	Configuring the bus communication (ST-87x-SB/ST-88x-SB).....	95
8.6.1	Configuration.....	95
8.6.2	Instructions.....	95
8.6.3	Cyclical telegrams.....	96
8.6.4	Acyclic telegrams.....	98
8.7	Test control system.....	102
8.7.1	Test – motor functions.....	102
8.7.2	Test – Sensors and peripherals.....	103
8.7.3	Test – Communication.....	104
8.8	Optimise settings.....	106
9	Operation.....	109
9.1	Operating modes.....	111
9.2	Switching the control system on and off.....	112
9.2.1	Switch on control system.....	112
9.2.2	Switches the control system off.....	113
9.3	Displays.....	114
9.3.1	Status LEDs.....	114
9.3.2	Display.....	116
9.3.3	Display modes.....	118
9.3.3.1	Creating/modifying display modes.....	139
9.3.3.2	Calculating and evaluating hexadecimal values.....	140

9.4	Vehicle remote control.....	142
9.4.1	Changing operating mode.....	143
9.4.2	Moving the vehicle manually.....	143
10	Faults.....	147
10.1	Displaying faults and errors.....	147
10.2	Error messages.....	148
10.3	Error codes.....	148
10.4	Fault types.....	149
10.5	Fault reset.....	150
11	Service and maintenance.....	153
11.1	Maintenance and cleaning.....	153
11.1.1	Maintenance.....	153
11.1.2	Cleaning.....	154
11.2	Removing / replacing the control system.....	154
11.2.1	Control system removal.....	155
11.2.2	Control system installation.....	156
11.3	Repairing the control system.....	156
12	Disposal.....	157
12.1	Information on disposal and environmental regulations.....	157
13	Technical specifications.....	159
13.1	Device.....	159
13.2	Input data.....	161
13.3	Output data.....	162
13.4	Interfaces.....	164
13.5	Cable lengths and specifications.....	164
13.6	Approvals and standards.....	165
14	Information and parameter assignment.....	167
14.1	Three-phase current asynchronous motor.....	167
14.1.1	Layout and function.....	167
14.1.2	How it works.....	168
14.2	Permanent magnet synchronous motor.....	171
14.2.1	Layout and function.....	171
14.2.2	How it works.....	172
14.2.3	Parameters for the settings of the controlled operation.....	174
14.2.4	Parameters for the settings of controlled operation (vector control).....	175
14.3	Brushless DC motors.....	176

14.3.1	Layout and function.....	176
14.4	Frequency converters.....	176
14.4.1	Layout and function.....	177
14.4.2	Rectifier.....	177
14.4.3	Intermediate circuit.....	177
14.4.4	Inverter.....	178
14.4.5	Control circuit.....	179
14.4.6	ST-87x/88x Current Monitor.....	179
14.4.6.1	Hardware short circuit shutdown.....	179
14.4.6.2	I ² t-monitor (maximum load integral).....	179
14.4.6.3	Software-based shutdown in the event of excess current....	181
15	Customer service and addresses.....	183
16	Index.....	185

1 Information on the description

1.1 Revision history

We reserve the right to make changes to the information present in this document, which result from our constant effort to improve our products.

Version	Date	Comment/reason for change
1	08.2017	Basic version
2	11.2017	Technical specifications extended Terminology changed (Software switch → configuration switch) Chapter 8.5 revised
3	01.2018	Type label changed
4	02.2018	Changes in the structure of Chapters 8 and 9
5	03.2018	Various changes in Chapter 8 – Commissioning
6	04.2018	Text corrections
7	08.2021	New chapter structure Corrections pin configuration X1, X13, X14
8	05.2022	Conductix-Wampfler Automation GmbH
9	03.2023	New start display
10	04.2023	Certification updated

1.2 How to use and store the description

This documentation forms part of the product. It contains important information and notes on using the product. It affects:

- Mechanical and electrical installation
- Commissioning
- Operation
- Maintenance and service

To work safely with the product, it is necessary to observe the safety notes and action instructions. All persons working with the product must have understood the user information in this description and apply it conscientiously. The operator must fulfil his duty of care and ensure that all persons working with the product have read and understood the user information and are implementing it.

This description forms part of the product and must be accessible to all persons working with the product at all times.

1.3 Applicable documents

The documents contained in the project documentation also apply if the device / system is part of a project-specific system plan.

The following documents are considered part of this description. They are located at the end of this description or they are included as an extra description in the scope of delivery.

- Connection diagram ANS
- Device drawing GER
- Document: STB_0010_ST-87x parameters
- Document: STB_0011_ST-87x error messages

Connected devices and components are covered by their own documentation.

1.4 Copyright protection

The contents, texts, drawings, pictures and other illustrations of this description are protected by copyright and subject to intellectual property rights. Any misuse is punishable by law.

Reproduction in whole or in part of this description is only permitted within the limits of the legal provisions of the copyright law. Any modification or shortening of the text is prohibited without the explicit written consent of Conductix-Wampfler Automation GmbH.

1.5 Illustrations

The illustrations that accompany this description have been purposely selected. They are provided for basic understanding and may differ from the actual design. No claims shall be accepted for possible discrepancies.

1.6 Brands

The popular names, trade names, production descriptions, etc. used in this description may constitute trademarks even without special designations and as such may be subject to legal requirements.

2 Warranty and liability

2.1 Warranty

The warranty only covers production defects and faulty components.

The manufacturer assumes no responsibility for damages caused during transport or unpacking. In no case and under no circumstances will the manufacturer be liable for defects or damages caused by misuse, incorrect installation or inadequate environmental conditions or from dust or corrosive substances.

Consequential damages are excluded from the warranty.

Should you have further questions regarding the warranty, please contact the supplier.

2.2 Limitation of liability

All information and notes in this description have been compiled taking into account the applicable standards and regulations, the state of the art and our many years of knowledge and experience.

Conductix-Wampfler Automation GmbH assumes no liability for damage and malfunctions during operation due to:

- Failure to comply with the description
- Non-intended use
- Use by untrained personnel
- Unauthorised alteration or modification
- Use of the product, despite negative transport inspection

Furthermore, Conductix-Wampfler Automation GmbH's warranty obligation will cease to exist in case of a failure to comply with the description.

3 Safety instructions

This section contains information on all safety aspects for optimum protection of personnel and for safe operation without malfunctions.

To prevent dangers, these notes must be read and followed by personnel. Only then can safe operation be guaranteed.

Of course, all legally applicable general safety and accident prevention regulations must be complied with.

Conductix-Wampfler Automation GmbH assumes no liability for damage or accidents that were caused by non-observance of these safety notes.

3.1 Warning concept

This description contains notes that must be observed for your own personal safety and to avoid property damage. Notes regarding your personal safety are highlighted by a warning triangle; notes regarding property damage do not have a warning triangle.

When several hazard levels occur, the warning always refers to the highest level. If a warning of injury to persons is indicated with a warning triangle, the same warning might include an additional warning of property damage.

3.1.1 Arrangement of warnings

If warnings refer to an entire section, they are placed at the beginning of the section (e.g. chapter start).







If warnings refer to a specific action instruction, they are placed in front of the respective action instruction.

3.1.2 Structure of warnings

- **SIGNAL WORD**
- ↳ Type of danger and its source
- ↳ Possible consequences, if not observed
- ↳ Danger avoidance measures
- ↳ Preventive measures

3.1.3 Signal words







Warnings are indicated using signal words based on hazard levels.

Signal word	Meaning
 	This combination of symbol and signal word indicates a possible dangerous situation that can result in death or serious injury if it is not avoided.
 	This combination of symbol and signal word indicates a possible dangerous situation that can result in minor injury if it is not avoided.
 	This combination of symbol and signal word indicates a possible dangerous situation that can result in material damage if it is not avoided.

3.1.4 Hazard symbols

Warnings of the groups 'danger' and 'warning' are content-based. They are presented with clear danger symbols.

Warnings of the 'caution' group do not have a specific danger symbol.

Warning signs	Type of danger
	Warning – automatic start-up.
	Warning - danger of crushing.
	Warning – high-voltage.
	Warning – danger of falling.
	Warning – falling objects.
	Warning – hot surface.

Warning signs**Type of danger**

Warning – danger zone.

3.1.5 Suggestions and recommendations

This symbol indicates important information to help you handle the product.

3.2 Intended use

The controller has been designed and constructed exclusively for the intended use described below.

Conductix/LJU vehicle control systems are equipped with frequency converters. These controllers are intended for use in industrial and commercial systems for the operation of motors, which can be used with frequency converters.

Electrical systems or machines must comply with the EU Directive 2006/42/EC (Machinery Directive) or the DIN EN 60204-1 standard if they are to be fitted with Conductix/LJU vehicle control systems. Intended operation is only permitted in compliance with the EMC Directive (2014/30/EU EMC).

3.3 Foreseeable incorrect use

Any use that goes beyond this description is forbidden.



⚠ WARNING!

Hazard from improper use!

Any use of the controller other than and/or beyond the one intended can cause hazardous situations.

- Only use the controller as intended.
- Only connect motors that are suitable for use with frequency converters.
- Do not connect any other loads.
- It is paramount to comply with all the specifications and permitted conditions at the place of use.
- Do not use the controller in potentially explosive atmospheres.
- Do not operate the controller in environments with harmful oils, gases, vapours, dusts, radiation, etc.
- Do not use the controller for the transportation of people or animals.

3.4 Modifications and alterations

For the purpose of avoiding hazards and for ensuring optimum performance, any modifications, additions, or alterations to the controller require Conductix-Wampfler Automation GmbH's express consent.



⚠ WARNING!

Injury hazard from structural modifications!

Unauthorised technical modifications can cause substantial bodily harm or material damage.

- Replace faulty control systems.
- A faulty control system should only be replaced by an identical control system.

3.5 Responsibility of the operator

The control system is used in an industrial environment. The operator of the control system is therefore subject to statutory obligations regarding work safety.

In addition to the work safety instructions in this description, the safety, accident prevention and environmental regulations applicable to the area where the control system is used must be complied with.

The following applies in particular:

- The operator must become familiar with the applicable work safety regulations and must also determine the dangers that are posed by the particular work conditions at the location where the control system is to be used by means of a risk assessment. This must be realised in the form of operating instructions for operating the control system.
- This description must be kept within easy reach of the control system be accessible to those persons charged with working both on and with the control system at all times.
- The specifications of the description must be adhered to fully and unconditionally.
- The control system may only be operated when in a perfect and operationally safe condition. The control system must be checked for detectable defects prior to each time it is put into service.
- The system operator must ensure that the responsibilities for activities on the system are unambiguously defined and only adequately qualified personnel familiar with the operating and safety regulations are working on and with the control system.

3.6 Personnel and qualifications

The product / system belonging to this description may only be handled by personnel qualified for the respective task. This is done taking into account the descriptions associated with the particular task, especially the safety and warning information contained therein.

Due to their training and experience, qualified personnel are able to recognize risks and avoid possible hazards when dealing with this product / system.



⚠ WARNING!

Injury hazard from insufficient qualification!

Improper handling can cause substantial bodily harm or material damage.

Installation and commissioning



⚠ WARNING!

Danger posed by faulty installation and initial commissioning.

The installation and initial commissioning of the control system require trained specialist personnel with sufficient experience. Faults with the installation may lead to potentially fatal situations or considerable material damage.

- Have installation and initial commissioning performed exclusively by employees of the manufacturer or by trained personnel authorised by it.
- Works on electric components may only be carried out by qualified electricians or persons instructed and supervised by a qualified electrician in accordance with the electro-technical regulations.
- Before carrying out any kind of work on the controller, make sure it is de-energised and secured against accidental reconnection.
- Prior to commissioning, ensure that all safety equipment is installed and functioning properly.
- Prior to commissioning, ensure that parameter assignment on the control system has been performed correctly in accordance with the electrical and mechanical conditions of the system.

Electrical work



⚠ WARNING!

Electrical hazard!

Contact with live parts poses an immediate danger to life. The touching of open terminals and wires may lead to death or serious injury.

- Only qualified electricians are allowed to work on electrical system components, devices or equipment.
- De-energise system parts to work on them.
- Check the de-energised state of system parts disconnected from the mains voltage before starting to work on them.
- Do not open covers during operation.
- Call on the assistance of a second person who can actuate the EMERGENCY-STOP mechanism or the main switch in an emergency, when working on live parts.
- Some components in the system may still be live even after the system has been switched off. They are specially designated. Ensure to follow the notes on their designation when working on these components!
- Use only insulated tools to work on the electric system!

Operation and maintenance

The operation and maintenance of the control system must only be performed by trained and qualified personnel. Staff undergoing instruction and training are allowed to perform activities on and with the control system under the constant supervision of a trained and qualified individual.

3.7 Special hazards



⚠ WARNING!

Live parts

Contact with live parts poses an immediate danger to life. Damage to the insulation or individual components can be life-threatening.

- In case of damage to the insulation, turn off power supply immediately.
- Check devices and connected components regularly. Any loose connections, damaged cables and insulations as well as all damages that could pose a risk to safety must be rectified immediately. Any faulty protection against accidental contact must be repaired immediately.
- Works on electric components may only be carried out by qualified electricians or persons instructed and supervised by a qualified electrician in accordance with the electro-technical regulations.
- Before carrying out any kind of work on the control system, make sure it is de-energised and secured against accidental reconnection.
- Always use insulated tools.



⚠ WARNING!

Electrical voltage after shutdown

Some components of the vehicle controllers, especially the intermediate circuit of the frequency inverters, may still retain voltage after switching off. Work on these components may only be carried out after the intermediate circuit has discharged!

Disconnect the power supply safely:

- Disconnect system from power.
- Disconnect collectors from busbars.

Waiting time after voltage isolation: At least 10 minutes



⚠ WARNING!

Start/stop switch

The start/stop switch does not disconnect the controller from the power supply. Dangerous voltage is present.

- The control system must be disconnected from the power supply when performing work on it.

**⚠ WARNING!****Automatic start-up of the system**

Death or serious injuries!

If the vehicle control system is in automatic mode or is being switched to automatic mode, an automatic start-up of the system is to be expected at any time.

3.8 Safety instructions for the system operator and manufacturer

**⚠ WARNING!****Start/stop switch**

The start/stop switch does not disconnect the controller from the power supply. Dangerous voltage is present.

- Installation of a main switch by the system operator or system manufacturer.
- All poles of the power supply must be able to be switched off and protected against being switched on again.
- The control system must be disconnected from the power supply when performing work on it.

**⚠ WARNING!****Unsafe control functions**

Risk of crushing limbs, catching and dragging of loose items of clothing due to moving machine parts.

- Implement safe control functions within your system controller, if your security concept demands safe functions.

**⚠ WARNING!****Safely reduced speeds**

Risk of crushing limbs, catching and dragging of loose items of clothing due to moving machine parts.

- If your safety concept requires reduced speeds, implement safely reduced speeds within your system control.

**⚠ WARNING!****Safety note for system integration****Warning about falling parts**

Depending on the control by higher-level sensors, shutting down the control system causes the drive to come to an immediate standstill and the motor brake to engage.

- Take this into account when performing your risk assessment for system integration.

3.9 Safety devices

**⚠ WARNING!****Danger to life from non-functioning safety devices!**

Security devices ensure a maximum degree of safety during operation. Never override safety devices, even if they obstruct work processes. Safety can only be guaranteed if the safety devices are intact.

- Before starting work, check whether the safety devices are fully functional and connected properly to the controller.
- Report any faulty safety devices immediately.
- Bring vehicles with defective safety equipment to a standstill immediately.
- Get safety devices repaired immediately.

**Connected safety equipment**

For further detailed information about which safety devices are connected to the controller, please refer to the connection diagram of the controller.

3.10 Safe isolation

The vehicle controller meets all the requirements of EN 61800-5-1 and provides reliable isolation of electronic and power connections.

To ensure safe isolation, all connected electrical circuits must meet the requirements for safe isolation.

4 Product description

4.1 Series 8

"Series 8" refers to vehicle control systems of the eighth generation.

4.2 87x / 88x series model name

The following table explains the systematic structure of the 8-series type name:

ST-881-SB (BLDC)

Control system	Series	Type	Power class	Features	Features
ST-	8	7	0	-SB	(BLDC)
Normal infeed		8	1	Communication via rail bus	BLDC motor control
			2		
			3		

4.3 87x / 88x series power classes

87x/88x series control systems are available in the following power classes:

Power classes		ST-87x	ST-88x
0	up to 0.75 kW / 2.5 A	ST-870	ST-880
1	up to 1.5 kW / 4.2 A	ST-871	ST-881
2	up to 2.2 kW / 6.0 A	ST-872	ST-882
3	up to 3.0 kW / 8.0 A	ST-873	ST-883

Tab. 1: 87x / 88x series power classes

4.4 87x / 88x series scope of functions

87x/88x-series control systems have the following scope of functions in the basic configuration:

		ST-87x	ST-88x
Controllable axes	1	✓	✓
Converter	1	✓	✓
Connections (Quantity)	Fixed	✓	✓
Connection configuration	Parameter-controlled	✓	
	Software-controlled		✓
Supported sensors	Fixed ("standard" sensors)	✓	✓
Software	Fixed scope of functions	✓	
	Project-specific		✓
Device size / design	Fixed	✓	✓

Tab. 2: Series 8 scope of functions

4.5 Type label

The following image shows an example of a type label of an ST-870 control system.

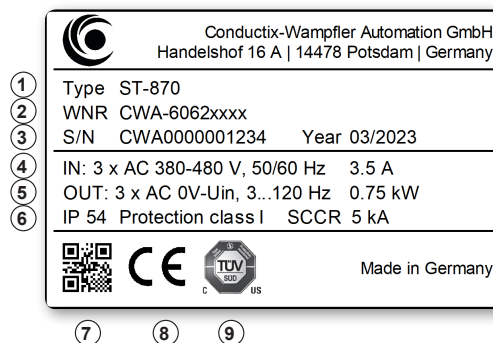

Fig. 1: ST-870 type label

- 1 Model name
- 2 WNR item number
- 3 Serial number, year of construction
- 4 Rated input voltage, rated input frequency, rated input current
- 5 Output voltage, output frequency, rated motor power
- 6 Protection type, protection class, short-circuit current
- 7 QR-Code (serial number)
- 8 CE marking
- 9 NRTL marking for NRTL-approved control systems

4.6 ST-87x / 88x designs

ST-87x / 88x-type control systems are split into power classes in three designs. The heat sinks and the external braking resistor are characteristic.

No heat sink is necessary in the power classes 0 to 1. ST-873 and 883-type control systems are fitted with retaining brackets at the factory.

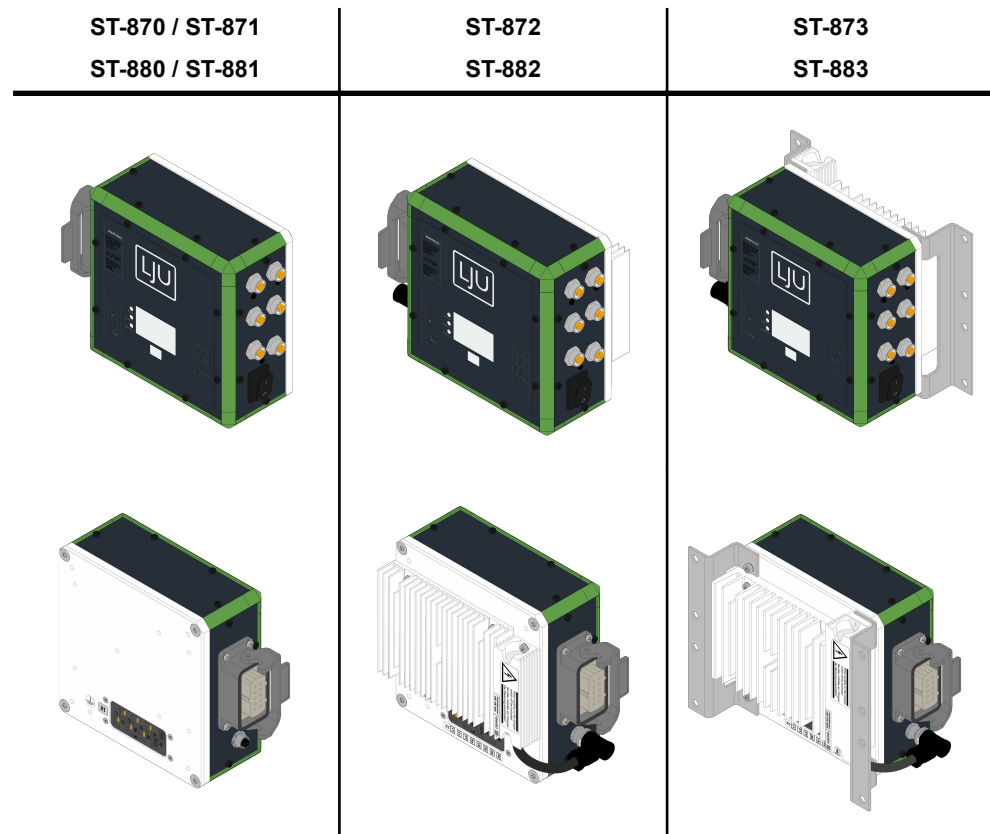

Tab. 3: ST-87x / 88x designs

4.7 Basic device

The following figure shows the most important parts of the control system.

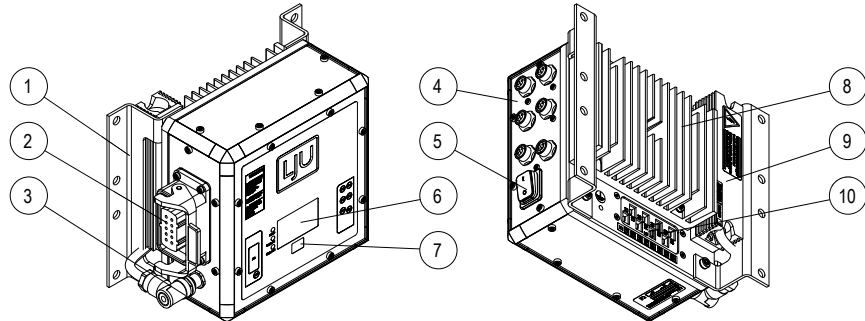

Fig. 2: ST-87x basic device

- 1 Mounting bracket (ST-873, -883)
- 2 Motor port
- 3 External brake resistor port (ST-872, -873, -882, -883)
- 3 BLDC motor monitoring port (ST-870, -871, -880, -881)
- 4 Sensor/component port
- 5 Start/stop switch
- 6 Display
- 7 Infra-red sensor/receiver
- 8 Heat sink (ST-872, -873, -882, -883)
- 9 External brake resistor (ST-872, -873, -882, -883)
- 10 Supply and data exchange port

5 Transport and storage

5.1 Transport



NOTICE!

Transport

Incorrect or improper transport may cause damage to the device.

- Only trained personnel are allowed to transport the device.
- If necessary, use suitable transport aids.
- Transport the devices with utmost care.
- Observe the symbols on the packaging.
- Do not remove packaging and transport securing devices until you are ready to start with the installation.

5.2 Transport inspection

Check the delivery for completeness and transport damage upon receipt.

Proceed as follows in case of any apparent damage:

- Refuse to accept the delivery or accept it only conditionally. Take note of the extent of the damage and write it down on the carrier's transport documents or delivery note.
- Initiate a complaints process and report the incident to the supplier. If Conductix-Wampfler Automation is your direct supplier you will find our contact information in this document.
↳ *Chapter 'Customer service and addresses' on page 183*



Claims for damages

Claim any defect as soon as it becomes apparent. Damages can only be claimed within the applicable claim periods.

5.3 Storage



NOTICE!

Storage

Incorrect or improper storage may cause damage to the device.

- Cover connections with protective caps during storage.
- Avoid mechanical stress and vibrations.
- Store in a dry and dust-free location.
- Regularly check the condition of the stored device.
- Keep environmental conditions as specified in the technical information.
- Keep the storage temperature as specified in the technical information.



NOTICE!

Storing control systems without supply voltage

Connect devices to power supply for 5 minutes after max. 2 years of standstill.

6 Mechanical installation

Objective	This section provides details on the mechanical installation. Electrical installation is possible following successful mechanical installation.
Responsible party	<p>The system integrator (e.g. system builder, operator) is responsible for trouble-free and safe installation. As the contact person, he responds to all the fitter's queries regarding safe-to-use equipment; e.g.:</p> <ul style="list-style-type: none">■ Fire protection■ Electrical equipment■ Ladders and scaffolding■ Requirements for assembly tools■ Lifting and transportation
Required personnel	<p>Due to their training and experience, only qualified and appropriately instructed personnel are able to correctly assess the respective initial situation, identify risks and avoid hazards.</p> <p>Personnel required for installation:</p> <ul style="list-style-type: none">■ Adequately qualified fitter
Required personal protective equipment	<p>The person responsible must ensure that the personnel under his responsibility are wearing the required personal protective equipment. The required personal protective equipment satisfies the requirements for the work to be carried out and all the requirements demanded by the scope of work.</p> <p>Personal protective equipment that fulfils its intended purpose:</p> <ul style="list-style-type: none">■ protects its wearer from injury;■ reduces the seriousness and severity of potential injuries. <p>Wear:</p> <ul style="list-style-type: none">■ Work protection clothing■ Safety shoes■ Protective gloves■ Protective goggles
Safety in the work area	<ul style="list-style-type: none">■ Note the safety signs in the area around the system.■ Pay attention to the safety notes in additional applicable documentation (supplier documents).

**Work safety**

Pay attention to company and task-specific work safety regulations, as well as the country-specific legal and safety regulations applicable at the location of use.

**Wear additional protective equipment**

As an employee, you wear protective equipment supplied by the area supervisor. If work tasks have been delegated only temporarily, then you also wear any protective equipment that has become additionally required.

Special hazards**⚠ WARNING!****Live parts**

Contact with live parts poses an immediate danger to life.

- Disconnect the system from the power supply before installing the mechanical and electrical parts of the control system.

**⚠ WARNING!****Danger of falling**

Danger of falling if the control system is mounted on typical assembly sites of a monorail.

- Provide safe ascent for all activities on the control system.
- Always use certified climbing aids.

**⚠ WARNING!****Falling loads**

Risk of fatality due to falling objects

- Do not stand under loads.
- Seal off areas of mechanical installation.
- Seal off danger areas.

6.1 Open spaces and cooling

87x / 88x-type control systems reach an operating temperature of approx. 70°C in load operations. In order to ensure the air circulation for cooling the control system, one must ensure sufficient open space around the control system.

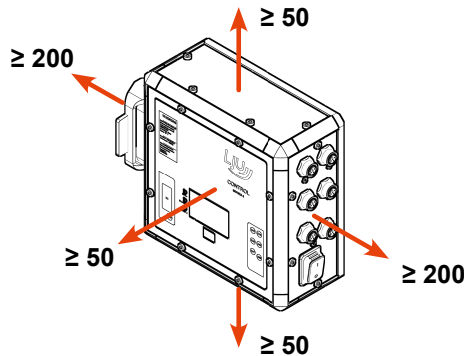

Fig. 3: Open spaces around the control system (mm)



⚠ CAUTION!

Hot surfaces

Risk of burns posed by hot surfaces of the control system and connected components.

- Install protective equipment and check it regularly.
- Prior to working on the control system, allow the connected components to cool down.



⚠ WARNING!

Risk of fire due to hot surfaces

Highly flammable materials may catch fire if they come in direct or indirect contact with the hot surfaces of the device.

- Ensure that the air around the device is constantly circulated.
- Do not place any flammable materials on top of the device.
- Keep flammable materials away from the housing surface and the heat sink.



Automatic shutdown

If the temperature of the converter or the heat sink of the control system reaches 80 °C, the converter is shut down automatically.

A fault message is output. Once the control system has cooled down, the fault can be acknowledged. The control system is then ready for operation once again.



Preventing heat sources

Prevent sources of heat in the immediate vicinity of the control system.

Assembly of control systems without heat sinks

When installing the control systems one must ensure unobstructed heat dissipation through the device's rear side. Adequate convection is to be ensured through a large-surface-area connection on a heat-dissipating bearing or by means of adequate air circulation.

Assembly of control systems with heat sinks

When installing control systems with heat sinks adequate circulation through the ambient air must be ensured.

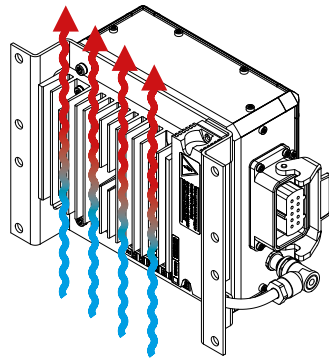

Fig. 4: Circulation through ambient air

6.2 Installation position

Installation in vertical position is prescribed (type label below).

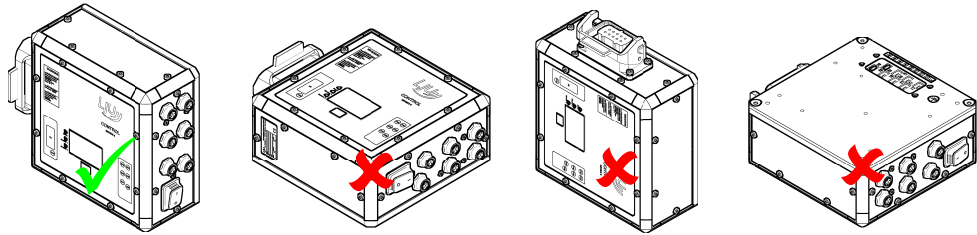

Fig. 5: Installation position

The following points must be noted when installing the control system:

- Legibility of the display
- Visibility of the status diodes
- Angle of incidence of the infra-red receiver
- Accessibility of the start/stop switch
- Ports accessible at all times

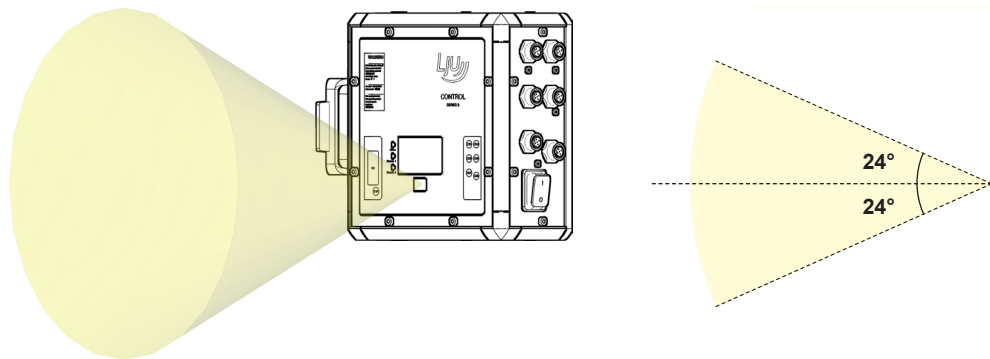

Fig. 6: Angle of incidence of the infra-red receiver (optical field of vision)

Data	Value	Unit
Incidence angle	48	°
Control system infra-red transmission range	1	m

6.3 Installation



NOTICE!

Collisions

Damage to system components

- Choose the position of the control system so that collisions with system components are excluded.



NOTICE!

Dampen impacts and vibrations

If the device is subjected to impermissible heavy impacts or vibrations, the amplitude and acceleration must be attenuated by means of appropriate measures.

- Use vibration-damping and vibration-eliminating systems.



General notes on installation and control systems

- *The control system may only be attached to the provided attachment points.*
- *Only attach the control system to the vehicle with suitable brackets.*
- *Use screw locks.*
- *The control system's switches must be accessible at all times.*
- *Display elements must not be covered.*
- *Do not cover cooling elements.*
- *Only connect external components to the control system according to the connection diagram.*
- *Secure plug connectors with safety devices (brackets, screw caps) against accidental loosening.*
- *Do not connect tensioned cables to the control system. Use strain relief devices.*

Place of installation

The vehicle control is intended for direct installation on the material-handling vehicle.

ST-87x / ST-88x attachment points

The 87x and 88x-type attachment points are located on the rear of the device.

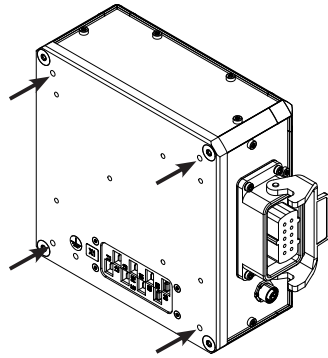

Fig. 7: Attachment points

ST-87x / ST-88x dimensional drawing

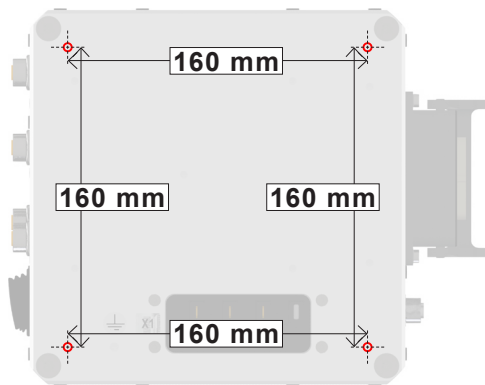

Fig. 8: Dimensional drawing



Alternative attachment points

If the attachment points do not match those of the carrier unit, then other adapters are available for fixing upon request.

6.3.1 Installation with direct screw connection

870, 871, 880 and 881-type controllers without heat sinks are installed at the attachment points of the device's rear side.

Type 872 and 882 controllers with heat sinks can be attached to the attachment points of the device's rear side or with retaining brackets (optional).

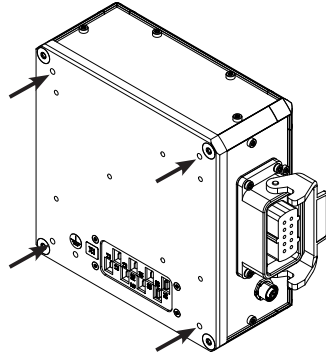

Fig. 9: Attachment points

Data	Value	Unit
Thread	M6	
Min. screw depth	6	mm
Max. screw depth	7	mm
Tightening torque	2	Nm

NOTICE!



Threaded hole damage

Exceeding the maximum tightening torque leads to damage to the thread.

- Only tighten screw connections with the specified tightening torque.

6.3.2 Installation with attachment bracket

Type 873 and 883 control systems with a heat sink are installed with attachment brackets.

The attachment brackets are pre-assembled on type 873 and 883 control systems.

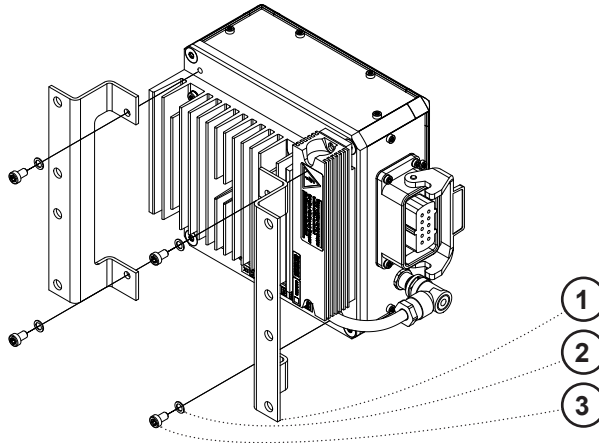

Fig. 10: Attachment bracket

- 1 Attachment bracket
- 2 Schnorr anti-vibration washer
- 3 Cylinder screw

Data	Value	Unit
Tightening torque	2	Nm



NOTICE!

Threaded hole damage

Exceeding the maximum tightening torque leads to damage to the thread.

- Only tighten screw connections with the specified tightening torque.

Attachment bracket dims

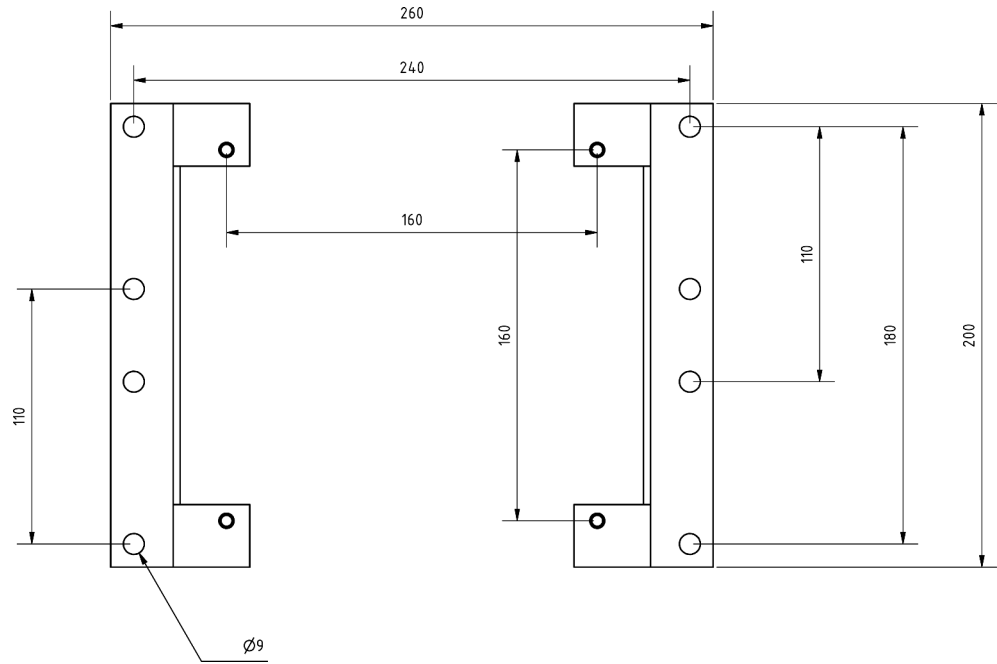

Fig. 11: Standard attachment bracket dims (mm)



Alternative attachment points

If the attachment points do not match those of the carrier unit, then other adapters are available for fixing upon request.

7 Electrical installation

Objective	This section provides details on the electrical installation. Commissioning is possible following successful electrical installation.
Responsible party	<p>The system integrator (e.g. system builder, operator) is responsible for trouble-free and safe electrical installation. As the contact person, he responds to all the fitter's queries regarding safe-to-use equipment; e.g.:</p> <ul style="list-style-type: none">■ Fire protection■ Electrical equipment■ Ladders and scaffolding■ Requirements for assembly tools
Required personnel	<p>Due to their training and experience, only qualified and appropriately instructed personnel are able to correctly assess the respective initial situation, identify risks and avoid hazards.</p> <p>Personnel required for electrical installation:</p> <ul style="list-style-type: none">■ Qualified electrician■ Adequately qualified fitter under the direction and supervision of a qualified electrician
Required personal protective equipment	<p>The person responsible must ensure that the personnel under his responsibility are wearing the required personal protective equipment. The required personal protective equipment satisfies the requirements for the work to be carried out and all the requirements demanded by the scope of work.</p> <p>Personal protective equipment that fulfils its intended purpose:</p> <ul style="list-style-type: none">■ protects its wearer from injury;■ reduces the seriousness and severity of potential injuries. <p>Wear:</p> <ul style="list-style-type: none">■ Work protection clothing■ Safety shoes■ Protective gloves■ Protective goggles
Safety in the work area	<ul style="list-style-type: none">■ Note the safety signs in the area around the system.■ Pay attention to the safety notes in additional applicable documentation (supplier documents).

**Work safety**

Pay attention to company and task-specific work safety regulations, as well as the country-specific legal and safety regulations applicable at the location of use.

**Wear additional protective equipment**

As an employee, you wear protective equipment supplied by the area supervisor. If work tasks have been delegated only temporarily, then you also wear any protective equipment that has become additionally required.

Special hazards**⚠ WARNING!****Live parts**

Contact with live parts poses an immediate danger to life.

- Disconnect the system from the power supply before installing the mechanical and electrical parts of the control system.

**⚠ WARNING!****Electric shock due to faulty PE connection or potential equalisation**

Risk of fatality posed by electric shock!

The vehicle control system must be earthed.

- Connect the PE connection on the rear side of the device to the system PE in accordance with EN 60204-1.

**⚠ WARNING!****Start/stop switch**

The start/stop switch does not disconnect the controller from the power supply. Dangerous voltage is present.

- The control system must be disconnected from the power supply when performing work on it.

**⚠ WARNING!****Danger of falling**

Danger of falling if the control system is mounted on typical assembly sites of a monorail.

- Provide safe ascent for all activities on the control system.
- Always use certified climbing aids.

7.1 Notes about electrical installation

7.1.1 Residual current circuit breaker and mains fusing



Residual current circuit breakers react very quickly, which may lead to the control system stopping frequently. Conductix-Wampfler Automation GmbH recommends not using them.



⚠ WARNING!

**Electric shock due to incorrect residual current circuit breaker
The control system may cause direct current in the protective conductor.**

Risk of fatality posed by electric shock!

- Install fuses at the start of the mains cabling.
- Install fuses behind the busbar junction.

Residual current circuit breaker (RCCD)

If the use of a residual current circuit breaker (RCCD) is prescribed for contact protection, only these types may be used on the power supply side of the frequency converter:

- Residual current circuit breaker (RCCD) type B
- Residual current circuit breaker (sensitive to universal current)

Mains-type fuse

The system must be fused on the mains side for safe operation. For mains-related protection, only use the following types of fuses:

Fuse links for cables and line protection - Operating categories: gL, gG

- Rated mains voltage \leq Rated fuse voltage
- Configure rated fuse current in line with the capacity of the frequency converter to 100% of the frequency converter current.

Circuit breakers - B, C

- Rated mains voltage \leq Rated circuit breaker voltage
- Rated circuit breaker current 10 % above frequency converter current

7.1.2 Electromagnetic compatibility

Reliable operation of frequency converters and components in the surroundings requires an electromagnetic compatibility (EMC) plan.

Generation of electromagnetic interference



The power circuit of the converter consists of the following components:

3-phase line filter

- Protects the device from external interference on the mains voltage.
- Keeps the interference of the pulse inverter away from the mains network and dissipates common-mode interference to the housing.

⚠ WARNING!

Leakage currents above 3.5 mA

Risk of fatality posed by electric shock!

- Establish safe PE connection
- The protective earthing (PE) must meet the requirements for systems with high leakage currents.

B6 rectifier

- Rectifies the 3-phase mains voltage.

Intermediate voltage circuit

- Smooths the DC voltage for the inverter.
- Keeps the differential-mode interference of the inverter away from the mains network.

IGBT pulse inverter

- The motor phase voltages are periodically switched between the positive and negative intermediate circuit voltage with the switch frequency of the inverter (usually 16 kHz).
- Voltage pulses (PWM) of varying lengths result. Motor inductances form sinus-like currents from this.



⚠ WARNING!

High charging/discharging currents

Risk of fatality posed by electric shock!

High charging/discharge currents caused by parasitic capacitances (motor winding to the housing and motor cable) have interference frequency portions up to the MHz range.

Without effective high-frequency potential equalisation, peak voltages of a few hundred volts may occur between converter and motor, which constitute significant danger.

- It is imperative you pay attention to EMC installation notes!
 ↳ Chapter 'EMC installation notes' on page 48



Voltage distortions due to harmonics

The control system is interference-suppressed for industrial applications as per EN61800-3.

The capacitive intermediate circuit in the device generates low-frequency harmonic currents on the mains side. These can lead to voltage distortions in operation on low-power networks.

Measures for reducing voltage distortions are only possible at the end of infeed point of the system.

7.1.3 EMC installation notes

EMC-compliant installation

To comply with EMC directive 2014/30/EU, the EMC product standard DIN EN61800-3 (adjustable speed electrical power drive systems; EMC requirements including special testing processes) applies to frequency converters.

The vehicle control systems are designed for use on industrial networks (second environment; PDS category 2) and appropriate interference-suppressed by means of an integrated line filter. Use in a residential environment may require additional interference-suppression measures against high-frequency interference.

EMC requirements are only met in conjunction with an EMC-compliant installation. The effectiveness of the EMC measures requires professional implementation. Even minor deviations from installation specifications could totally nullify their effectiveness.

Cables

Only use shielded motor cables with external shielding made from copper braiding.

Cables for brake and temperature sensor must each have their own inner shielding. (E.g. Ölflex Servo 719 CY or Ölflex Servo 796 CP from Lapp-kabel (Fig. 12))

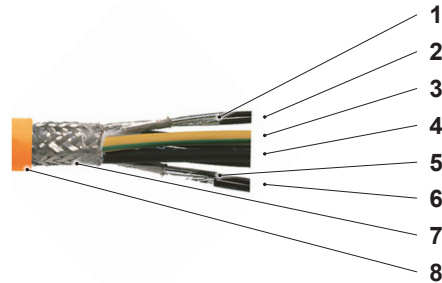

Fig. 12: Shielded motor cable

- 1 Brake cable shield
- 2 Brake cable (2X)
- 3 Motor feed cable, PE (1X)
- 4 Motor feed cable, phase (3X)
- 5 Temperature sensor cable shield
- 6 Temperature sensor cable (2X)
- 7 External shield
- 8 Outer jacket

Connections

Prevent motor cable interruptions caused by additional plug connections (motor connectors or intermediate connectors). Each connector possesses additional contact resistances, thus deteriorating the high-frequency potential equalisation.

Connect outer shield of the motor cable on the motor cable connector at the control system and at the motor to an EMC cable screw connection.

Connect copper braiding across the entire cable length.



In the case of motors with terminal boxes, note that the terminal box is metallic and is conductively connected to the motor housing over a large surface area.

Only connect inner shields for the brake and temperature sensor cables on the motor connector on the control system. Fold shielded stranded wire outwards and connect with the outer shield in the metallic EMC cable screw connection.

In the case of control systems with encoder connections, only connect the shield of the encoder cable to the M12 connector on the control system, and only use cables with wires twisted in pairs.

Only connect external components with digital interfaces (position readers, distance measurers, etc.) to the control system using shielded cables.

In the case of pre-assembled shielded M12 cables, the shield is connected on both sides. The external components are usually installed so as to be insulated from the housing.

NOTICE!



If the connector is connected of an external component connected to the housing so as to be conductive, it must be installed in insulated fashion.



Fig. 13: EMC screw connection ¹

¹ Type SKINTOP MS-SC-M from Lappkabel

Cable routing

Prevent narrow, parallel routing of power and sensitive (unshielded) signal cables, especially over long distances.

Only cross cables at right angles if possible.

Prevent spare loops in all connection cables

Route motor cables over the shortest possible distances closely to the structural parts of the suspension gear or at the edges of metallic cable ducts to minimise noise emissions.

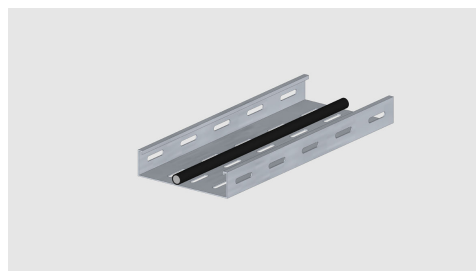

⊗ Not recommended

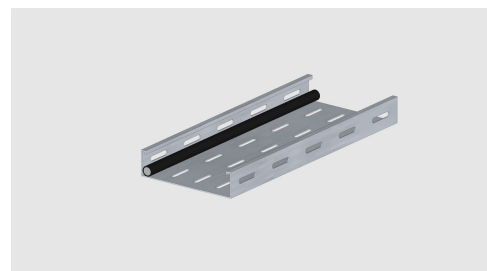

⊙ Recommended



Free-floating cables

Free-floating cables work as active and passive antennae!

Earth

Unused cables must be earthed at both ends.

Earth the control system and the motor on the vehicle. Connect all moving parts of the vehicle to one another so as to be electrically conductive.

Ensure large-surface-area connections of excellent conductivity for all earthing and shielding connections.

Painted parts require additional measures for paint-free contact areas, such as threaded holes for screw connections, special washers (for penetrating the paint coating) or the removal of coats of paint.

For earthing connections of moving components (e.g. control systems on painted parts or vibration dampers, parts of the suspension gear), use copper-braided strips for high-frequency potential equalisation.

Place copper-braided strips as short and close as possible onto metal parts for optimum effect.



⚠ WARNING!

Leakage currents above 3.5 mA

Risk of fatality posed by electric shock!

- Establish safe PE connection
- The protective earthing (PE) must meet the requirements for systems with high leakage currents.



NOTICE!

PE connections across single conductors

PE connections across single conductors enable potential equalisation only for low-frequency currents and can discharge residual currents. They therefore meet the safety requirements.

Single conductors are not effective for high-frequency potential equalisation.



Interference caused by motor cable

The interference caused by the wires in the motor cable cancel each other out in that the interference currents flow back to the control system through the outer shield whereby the magnetic fields outside the motor cable cancel each other out and no noise emissions are generated.

7.1.4 Cable routing

Please note with respect to cable routing:

- Use appropriate cables.
- Route cables for power and data separately.
- Maintain a distance between power and data cables.
- Avoid parallel-running cables over long distances.



maximum cable length between control system and motor(s)

- 3 m

7.1.5 Control system motor output

A capacitive load must not be present at the motor output. Only ohmic/ inductive loads may be connected.



NOTICE!

Capacitive loads

Damage to the controller

The vehicle control systems are only suitable for operating motors (ohmic-inductive loads).

- Observe permissible motor sizes and cable lengths.
- Do not connect any capacities. Capacitive loads increase switching losses and may destroy transistors.

7.1.6 Protective measures



⚠ WARNING!

Protective earthing in mobile systems

Risk of fatality posed by electric shock!

In mobile systems with direct grid feed-in, all electrical components must have a properly connected PE connection for protective grounding through the grid feed.

Overhead monorail direct grid feed

Protective earthing (PE connection) in overhead monorail applications is ensured by two consumers independent of one another on the contact line.

- Control system contact line PE connection
- Vehicle frame contact line PE connection

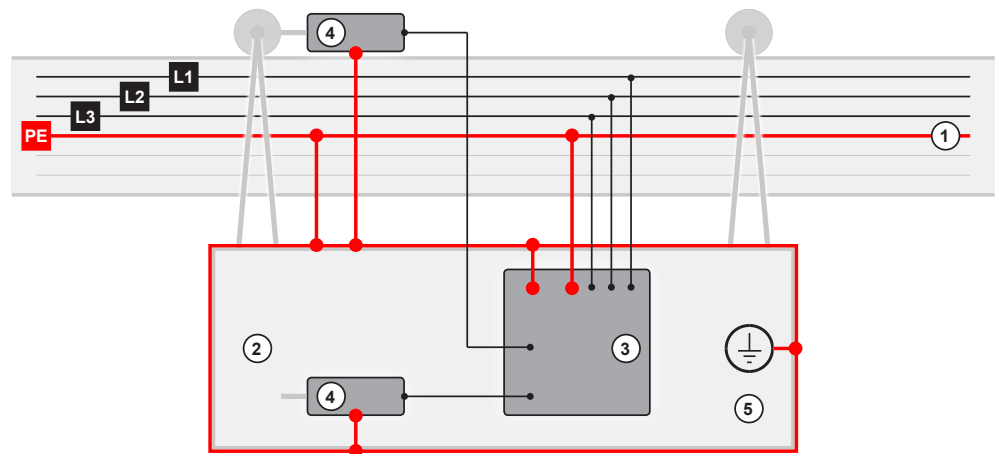

Fig. 14: Direct grid feed (diagram)

- 1 Overhead monorail rail with PE conductor
- 2 Overhead monorail vehicle
- 3 Vehicle control system
- 4 Motors
- 5 Vehicle earth

7.2 Connecting the electrical parts of the control system



NOTICE!

Note control system type

Operating a control system on an incorrect command system leads to serious damage and to control system failure.

- Only connect control system with PCM configuration to PCM systems.
- Only connect control system with bus configuration to bus systems.
- Check the control system configuration prior to connection and commissioning.
- Model name of the control system must match the configuration of the communication version.



NOTICE!

Malfunctions due to improper device connection

Improper device connection may lead to malfunctions during operation.

Follow the connection instructions below!

Make connections to the busbars and external components as follows:

1. ➤ Ensure that no voltage is present before connecting.
 - Switch off the vehicle control system.
 - Disconnect all busbars from the power supply and secure them against being switched on again.
2. ➤ Connect the current collectors and external components.
 - Only connect the current collectors and external components to the vehicle control system according to the [ANS] connection diagram.
 - To ensure that the protection class is achieved, only use the supplied plugs and threaded M12 plug connectors.
 - Secure plug connections against accidental loosening by means of appropriate safeguards (brackets, screw caps).
 - Do not connect cables to the vehicle control system under tension. Use strain reliefs.

**Connection diagram**

Observe the [ANS] connection diagram supplied with your control system.

7.3 Electrical connections

7.3.1 Connection overview

ST-87x / 88x connections

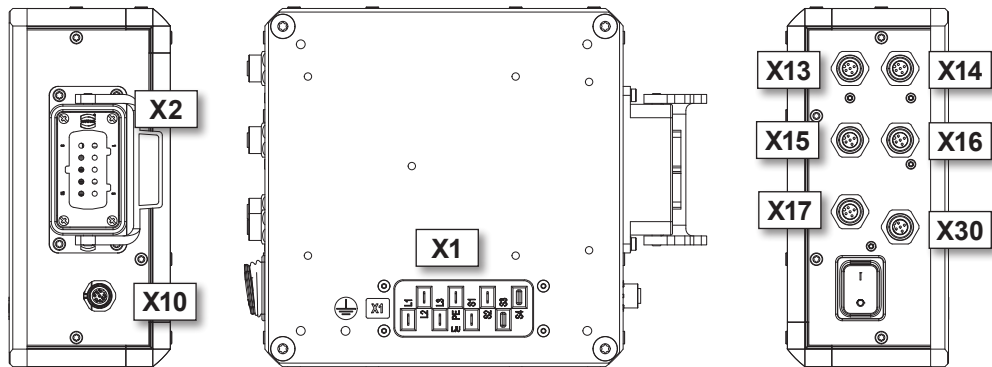

Connection		Designation	Use	
X1		Supply	Power supply	
			Rail bus	With bus system
			PCM / HW	With PCM system
			Z-stop	With Z-stop system
X2		Motor	<ul style="list-style-type: none"> ■ Motor ■ Brake ■ Temperature sensor 	
X10	ST-870 / ST-871 ST-880 / ST-881	Encoder	■ Encoder	For PMS/BLDC motor
			■ Thermal protection	
	ST-872 / ST-873 ST-882 / ST-883	Brake resistor	External brake resistor	
X13 X14 X15 X16 X17		Sensors	<ul style="list-style-type: none"> ■ Sensors ■ LJU bus nodes ■ etc. 	
X30		USB	DataCom-Stick DCS-8	

Tab. 4: ST-87x / 88x connection

7.3.2 X1 - Supply



⚠ WARNING!

Live connections

Risk of fatality posed by electric shock!

FASTON connection

- Use secure, insulated blade receptacles.
- Use blade receptacles as per standards DIN 46 245 part 3 or DIN 46 247 part 3 or DIN 46 346 part 3.
- Use insulating housing specified by the manufacturer.
- Check firm fitting and latching function.
- Replace blade receptacles without latching function.

Function	Connection type	Connection image
Supply	FASTON	
	6.3 mm	
	8-pole	

Configuration	Rail bus	PCM / HW / Z-stop
Pin	Signal	Signal
L1	Phase L1	Phase L1
L2	Phase L2	Phase L2
L3	Phase L3	Phase L3
PE	PE	PE
S1	<i>Unassigned</i>	S1 commands
S2	<i>Unassigned</i>	M messages
S3	SB_A	Z1 Z-stop
S4	SB_B	Z2 Z-stop

Tab. 5: X1 pin assignment

STB_0004, 10, en_GB



- *Protect blade terminal contact from contact with water or other corrosive substances.*
- *Cover unused contacts.*

7.3.3 X2 - Motor



NOTICE!

Motors with integrated brake rectifiers

Damage to or malfunctions of the drive unit when connection motors with integrated brake rectifier.

- Use motors without brake rectifier.
- Remove brake rectifiers subsequently.

Function	Connection type	Connection image
Motor	Harting	
	HAN10B	
	HAN10E use	

Configuration

Pin	Signal	Function
1	U	
2	V	
3	W	
4	<i>Unassigned</i>	
5	<i>Unassigned</i>	
6	B1 +	Brake
7	B2 -	Brake
8	B1 +	Brake *
9	PTC T +	Motor temperature sensor
10	PTC T -	Motor temperature sensor

Configuration

Pin	Signal	Function
-----	--------	----------

* Connected with pin 6 via internal bridge.

Tab. 6: X2 pin assignment



Motor cable at X2

- Cable specification: multi-core, shielded, max. 3 m.
- Shield wires for thermistor and brake control within the cable separately.
- Connect outer shield to PE of control system and motor.
- Only connect the shielding for thermal resistor and brake controller to the PE of the controller.

7.3.4 X10 - BLDC motor encoder

Function	Connection type	Connection image
BLDC motor encoder	M12 socket	
	8-pole	
	A-coded	

Configuration

Pin	Signal	Function
1	+ 5 V DC	Supply
2	GND	Thermal protection
3	GLK	Encoder
4	DO	Encoder
5	/CS	Encoder
6	KTY	Thermal protection
7	Switch	Brake monitoring
8	+ 5 V DC	Brake monitoring

Tab. 7: X10 BLDC motor pin assignment

STB_0004, 10, en_GB

7.3.5 X10 - Brake resistance

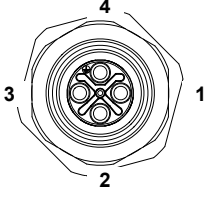
Function	Connection type	Connection image
Brake resistor	M12 socket	
	4-pole	
	D coded	

Configuration

Pin	Signal	Function
1	B+	Brake resistor voltage
2	<i>Unassigned</i>	
3	B-	Brake resistor voltage
4	<i>Unassigned</i>	

Tab. 8: X10 pin assignment

7.3.6 X13 - Sensors

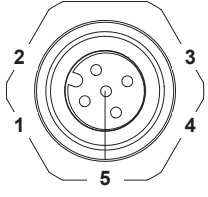
Function	Connection type	Connection image
Sensors	M12 socket	
	5-pole	
	A-coded	

Configuration

Pin	Signal	Function
1	+ 24 V DC	Supply
2	<i>Do not use</i>	
3	GND	
4	+ 24 V DC	Digital IN
5	<i>Unassigned</i>	

Tab. 9: X13 pin assignment

7.3.7 X14 - Sensors

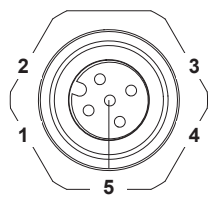
Function	Connection type	Connection image
Sensors	M12 socket	
	5-pole	
	A-coded	

24 V configuration assignment

Pin	Signal	Function
1	+ 24 V DC	Supply
2	+ 24 V DC	Digital IN
3	GND	
4	+ 24 V DC	Digital IN
5	+ 24 V DC	Digital IN

5 V configuration assignment

Pin	Signal	Function
1	+ 24 V DC	Supply
2	+ 5 V DC	Digital IN
3	GND	
4	+ 5 V DC	Digital IN
5	<i>Do not use</i>	

Tab. 10: X14 pin assignment

7.3.8 X15 - Sensors

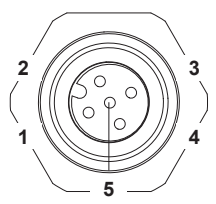
Function	Connection type	Connection image
Sensors	M12 socket	
	5-pole	
	A-coded	

STB_0004, 10, en_GB

Configuration

Pin	Signal	Function
1	+ 24 V DC	Supply
2	+ 24 V DC	Digital IN
3	GND	
4	+ 24 V DC	Digital IN
5	<i>Unassigned</i>	

Tab. 11: X15 pin assignment

7.3.9 X16 - Sensors

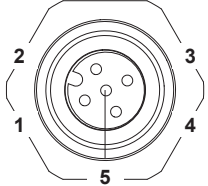
Function	Connection type	Connection image
Sensors	M12 socket	
	5-pole	
	A-coded	

Assignment for configuration for digital IN

Pin	Signal	Function
1	+ 24 V DC	Supply
2	+ 24 V DC	Digital IN
3	GND	
4	+ 24 V DC	Digital IN
5	<i>Unassigned</i>	

Alternatively: Assignment for configuration for LJU bus

Pin	Signal	Function
1	+ 24 V DC	Supply
2	Data_A	LJU bus
3	GND	
4	Data_B	LJU bus
5	<i>Unassigned</i>	

Tab. 12: X16 pin assignment



Data line at X16

If the X16 connection is configured as an LJU bus connection, shielded connection lines must be used.

7.3.10 X17 - Sensors

Function	Connection type	Connection image
Sensors	M12 socket	
	5-pole	
	A-coded	

Configuration

Pin	Signal	Function
1	+ 24 V DC	Supply
2	+ 24 V DC	Digital OUT
3	GND	
4	+ 24 V DC	Digital IN
5	+ 24 V DC	Digital OUT

Tab. 13: X17 pin assignment

NOTICE!



Excessive total current of external consumers

The total current of all external 24 V consumers at the digital outputs and the RS485 interface must not exceed 1.0 A.

7.3.11 X30 - USB

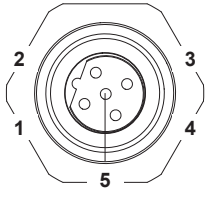
Function	Connection type	Connection image
USB	M12 socket	
	5-pole	
	B-coded	

Configuration

Pin	Signal	Function
1	+ 5 V DC	
2	USB_data -	
3	GND	
4	USB_data +	
5	<i>Unassigned</i>	

Tab. 14: X30 pin assignment

**NOTICE!****USB connection**

Connecting unapproved devices may lead to damage to the control system or the connected device.

- Only connect devices approved by Conductix-Wampfler Automation GmbH to the USB port.

7.4 Earthing the control system

The vehicle controller must be earthed for proper operation. To do this, connect the PE connection on the rear side of the device to the system PE in accordance with EN 60204-1.

The PE connection is indicated by the symbol for protective grounding. ⊕

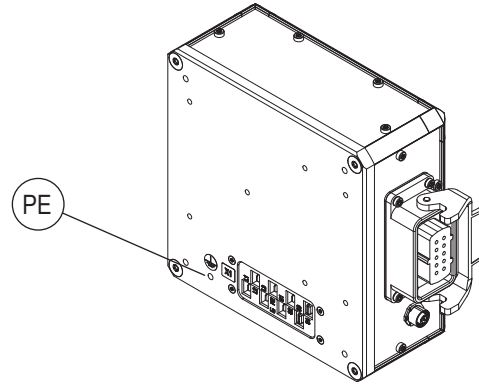

Fig. 15: ST-87x/88x PE connection

Threaded hole	M6, 8 mm deep
Tightening torque	4 Nm max.
Cable type	Earth wire or braided copper strip
Conductor cross section	$\geq 2.5 \text{ mm}^2$ (AWG 14) Like the wire cross section of L1, L2, L3 at a minimum!

Tab. 15: ST-87x / 88x PE connection

8 Commissioning

Objective	This section provides details on correct commissioning. Daily operation can start following successful commissioning.
Responsible party	<p>The system integrator (e.g. system builder, operator) is responsible for trouble-free and safe commissioning. As the contact person, he responds to all the commissioner's queries regarding safe-to-use equipment; e.g.:</p> <ul style="list-style-type: none">■ Fire protection■ Electrical equipment■ Ladders and scaffolding
Required personnel	<p>Due to their training and experience, only qualified and appropriately instructed personnel are able to correctly assess the respective initial situation, identify risks and avoid hazards.</p> <p>Personnel required for commissioning:</p> <ul style="list-style-type: none">■ Staff of Conductix-Wampfler Automation GmbH■ Sufficiently trained specialist personnel
Required personal protective equipment	<p>The person responsible must ensure that the personnel under his responsibility are wearing the required personal protective equipment. The required personal protective equipment satisfies the requirements for the work to be carried out and all the requirements demanded by the scope of work.</p> <p>Personal protective equipment that fulfils its intended purpose:</p> <ul style="list-style-type: none">■ protects its wearer from injury;■ reduces the seriousness and severity of potential injuries. <p>Wear:</p> <ul style="list-style-type: none">■ Work protection clothing■ Safety shoes■ Protective gloves■ Protective goggles
Safety in the work area	<ul style="list-style-type: none">■ Note the safety signs in the area around the system.■ Pay attention to the safety notes in additional applicable documentation (supplier documents).

**Work safety**

Pay attention to company and task-specific work safety regulations, as well as the country-specific legal and safety regulations applicable at the location of use.

**Wear additional protective equipment**

As an employee, you wear protective equipment supplied by the area supervisor. If work tasks have been delegated only temporarily, then you also wear any protective equipment that has become additionally required.

Special hazards**⚠ WARNING!****Open connections**

Contact with live parts poses an immediate danger to life.

- Work on open connections only by trained personnel.
- Do not put control system into service with open connections.
- Take protective measures against accidental contact with open connections.

**⚠ WARNING!****Missing protective coverings**

Risk of fatality posed by electric shock!

- Install missing protective coverings in compliance with regulations.
- Replace damaged protective coverings.
- Do not put control system into operation without protective coverings.

**⚠ WARNING!****Ineffective emergency stop**

Danger posed by uncontrolled device behaviour when the emergency-stop function is ineffective.

- Installation and commissioning only by trained personnel.
- Commissioning only with functioning emergency-stop equipment.

**⚠ WARNING!****Incorrect device settings**

Device malfunctions due to incorrect configuration.

Death or serious injuries could result.

- Installation and commissioning only by trained personnel.
- Check device settings.

**⚠ WARNING!****Impact and crushing due to motor (suddenly) starting up.**

Risk of crushing limbs, catching and dragging of loose items of clothing due to moving machine parts.

- Ensure that there are no people in the work area of powered parts before activating the control system.
- Instructions for initial commissioning for testing the connected sensors and the input parameters / training of personnel.
- Keep clear of moving system parts.
- Do not reach into the running machine.
- Wear tight-fitting work clothes.
- Pay attention to optical and acoustic warning equipment.



⚠ WARNING!

Danger of falling

Danger of falling if the control system is mounted on typical assembly sites of a monorail.

- Provide safe ascent for all activities on the control system.
- Always use certified climbing aids.



NOTICE!

Danger posed by electric arcs

Damage to electrical components.

- Pull cable connections when they are not voltage.
- Only connect cable connections when they are de-energised.

8.1 Notes about commissioning



Transfer of risk

The transfer of risk occurs when the operating parameters are entered and the operating parameters are transferred to the vehicle control system.

Pre-set parameter values

The vehicle control system is supplied without valid parameters. This status is indicated by the message **[FDA0]** on the display of the vehicle control system (following activation).

The correct functioning of the control system is only ensured once the operating parameters based on the mechanical and electrical conditions of the system have been entered.



NOTICE!

Pre-set parameter values

Control systems are subjected to testing by Conductix-Wampfler Automation GmbH before delivery. In this process, the software is installed and test parameters are set.

The pre-set parameter values are **not customer-specific** and may differ considerably from system-specific parameter values.

8.2 Requirements

Requirements for commissioning the control system:

- Correct mechanical installation
- Correct electrical installation
- System and drives fit the agreed project specifications
- Safety precautions have been taken so that no danger is posed to man or machine.
- Drive units are secured against unintended start-up by means of suitable safety measures.
- Manual programming device MU-705 (operating instructions)
- Manual remote control FB-606 (operating instructions)
- Software description for the control system
- Software description of the bus master (if used)
- Technical details for the drive and the mechanics (e.g. wheel diameter, gear ratio, etc.)

Motor data

Before parameter assignment, take the following details from the type label or data sheet of the connected motor.

Specification	Unit	For configuring the following parameters:	
Rated current	A	[In_]	Rated motor current
Nominal voltage	V	[Un_]	Rated motor voltage
Cos ϕ (motor efficiency)		[Cph_]	Motor cosine phi
Rated speed	rpm	[Rot_]	Rated motor speed
Gear ratio		[Tra_]	Motor gear ratio

8.3 Commissioning procedure

- (1) **Switch on control system**
 - ↳ Chapter 'Switch on control system' on page 73

- (2) **Assign control system parameters**
 - ↳ Chapter 'Assign control system parameters' on page 75
 - Edit vehicle parameters and configuration switches and transfer them to the vehicle control system.
 - Process vehicle tables and transfer to vehicle control system.

- (3) **Configure the bus communication (ST-87x-SB/ST-88x-SB)**
 - ↳ Chapter 'Configuring the bus communication (ST-87x-SB/ST-88x-SB)' on page 95
 - Configure the rail bus communication between vehicle control system and iDM system or bus master system.

- (4) **Test control system**
 - ↳ Chapter 'Test control system' on page 102
 - Test sensors and peripheral devices
 - Test motor functions
 - Test communication

- (5) **Optimise settings**
 - ↳ Chapter 'Optimise settings' on page 106
 - Adapt vehicle parameters to ambient conditions.
 - Adapt configuration switches to ambient conditions.
 - Adapt vehicle tables to ambient conditions.

- (6) **Control system is ready for operation.**

8.4 Switch on control system



NOTICE!

Motor current configuration

Motor currents that are set too high may damage any "small" motors that are connected.

- Check motor current settings (parameters) prior to activation.



Automatic start-up

- After activation, the control system goes into automatic mode autonomously

→ Set start/stop switch to [I]

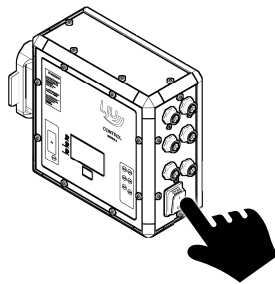

⇒ The control system starts.

Display during activation

After switching on, the display shows the "Conductix" logo during the start delay period.

The start delay is set in parameter [T0].

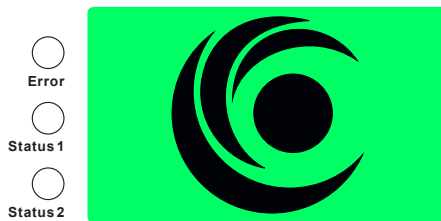

Fig. 16: Display during activation

**Missing parameters**

Since there are not yet any parameters in the control system, error messages are displayed after the start process.

The [Error] LED flashes or lights up permanently.

↪ Chapter 'Status LEDs' on page 114

8.5 Assign control system parameters

This chapter describes the basic procedure for assigning parameters to a vehicle control system.

Defined data records are edited by means of the MU-705 manual programming device or the MU-705 Utility software, and then transferred to the vehicle control system using the MU-705 manual programming device. Once the transfer is completed successfully, the vehicle control system has parameters assigned.

These data records consist of:

- Parameters and configuration switches
- Vehicle tables

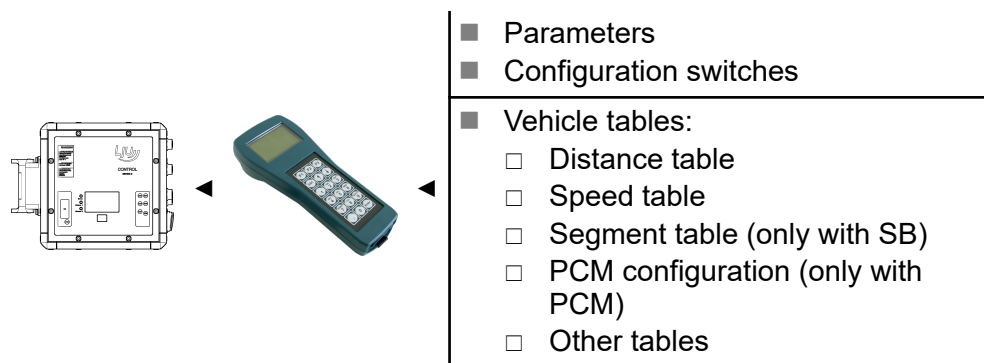

Reference

Information on the MU-705 manual programming device can be found in the document:

- *BDA_0005_MU-705.pdf*

This document is part of the project documentation and is available for download at www.conductix.com.



Reference

Information on the MU-705 Utility software can be found in the document:

- *MU-705 Utility v2.x_PB0001.pdf*

This document is part of the project documentation and is available for download at www.conductix.com.



Rail bus projects

In rail bus projects (ST-87x-SB/ST-88x-SB), it is also possible to edit, save and transfer parameters, configuration switches and tables to the vehicle control system using the iDM-SyMa (iDM system) or DKZ-Para (bus master system).

Requirement: properly configured iDM system or bus master system

Information on the iDM-SyMa can be found in the document:

- *SWB_0005_iDM-SyMa.pdf*

Information on the DKZ-Para can be found in the document:

- *DKZPARA Win v3.x TCPIP_PB0006.pdf*

These documents form part of the project documentation or can be downloaded from www.conductix.com.

8.5.1 Vehicle parameters and configuration switches

The data records for vehicle parameter assignment, in which values are defined for particular vehicle functions, consist of vehicle parameters and configuration switches.

The vehicle behaviour is specified using vehicle parameters and the configuration switches. Furthermore, different control system functions can be activated, deactivated and modified. The parameters are set according to the system requirements.



Monitoring

All monitors are always activated. Unnecessary monitors must be deactivated during commissioning, depending on the application.

Types

Following parameter types are used:

- General parameters
- Drive parameters – Configuration of the drive
- Motion parameters – Configuration of the movements
- Positioning parameters – Configuration of the positioning behaviour
- Peripheral parameters – Configuration of connected sensors and peripherals
- PCM parameters – Configuration of the communication via PCM
- Rail bus parameters – Configuration of the communication via rail bus
- Configuration switches - Function settings



Reference

All parameters and configuration switches for the configuration of control systems ST-870, ST-871, ST-872, ST-873 are described in a separate document.

- [STB_0010_ST-87x-Parameter.pdf](#)

Parameter values

Positive values from 0 to a maximum 65535 can be set as parameter values. The value range is limited further for some parameters.



Parameter values

Parameter values are held by the MU-705 manual programming device at reasonable limits.

It is not possible to set a value beyond this defined range with the MU-705 manual programming device. If parameters have to be transferred to the control system in a way other than using the MU-705 manual programming device, you have to note the specified value range. If a parameter value is outside the specified limits, this may lead to a vehicle control system malfunction or to an error message.

NOTICE!



Pre-set parameter values in the MU-705 manual programming device

All parameters on the delivered MU-705 manual programming device are pre-set with valid values, although not necessarily ones that conform to the system requirements.

- Every parameter value must be checked!

Configuration switch

Configuration switches are a part of the vehicle parameters. They activate or deactivate individual control system functions.

Each configuration switch can only assume one of two states:

- on
- off

8.5.1.1 Creating and saving parameters and configuration switches

Parameters and configuration switches are edited and saved in the MU-705 manual programming device and in the MU-705 utility software.

The parameters are organised for processing according to the logical sequence of the parameter assignment steps.

If a MU-705 manual programming device is delivered for control purposes, all the parameters and configuration switches specific to the control system are pre-set with valid values, but not necessarily those that conform to the system requirements. The *[PAR]* parameter (release key) is one exception.

Editing and saving parameters and configuration switches with the MU-705 manual programming device:

1. ▶ Open menu item "Parameters" → "Modify data".
2. ▶ Edit parameters or configuration switches.
3. ▶ Press ESC to exit menu item.
 - ⇒ Modifications to the parameters and configuration switches are stored in the MU-705 manual programming device.



Creating individual parameters

If only individual parameters of a pre-configured vehicle control system have to be adjusted as part of system optimisation, it is recommended to read and archive the parameters and settings for the configuration switches from the vehicle control system prior to modification. This ensures that the values in the MU-705 manual programming device match those in the vehicle control system.



NOTICE!

Regular data backups

Property damage may result from data losses.

- Regularly perform backups of your data onto a separate computer.
- For backups on a PC, it is recommended to use the MU-705 Utility program.

**Rail bus projects**

In rail bus projects, it is also possible to edit, save and transfer parameters, configuration switches and tables to the vehicle control system using the iDM-SyMa (iDM system) or DKZ-Para (bus master system).

Requirement: properly configured iDM system or bus master system

8.5.1.2 Transferring parameters and configuration switches

Parameters and settings of the configuration switch are transferred to the vehicle control system using the MU-705 manual programming device.

Transferring parameters and configuration switches with the MU-705 manual programming device:

1. ➤ Open menu item "Parameters" → "Write data".
2. ➤ Press the F1 key [Yes] to confirm the 'Send' request.
3. ➤ Establish infrared communication.
 - ⇒ Parameters and settings of the configuration switch are transferred from the MU-705 manual programming device to the vehicle control system.

**Parameters and configuration switches**

The parameters and settings of the configuration switches are always transferred together!

**Rail bus projects**

In rail bus projects, it is also possible to edit, save and transfer parameters, configuration switches and tables to the vehicle control system using the iDM-SyMa (iDM system) or DKZ-Para (bus master system).

Requirement: properly configured iDM system or bus master system

8.5.2 Vehicle tables – PCM

Vehicle tables contain data, which is accessed by certain control system functions. This data is assigned to the system in which the vehicle control system is used.

Values are defined in the vehicle tables which relate to motion and positioning functions.

These tables are:

- Configuration tables
- Speed tables
- Distance tables



NOTICE!

Table values as per checked system documentation

For fault-free operation of the vehicles, the table values must be checked using the system documentation.

8.5.2.1 PCM commands

PCM commands

Structure of a PCM command

A PCM command is a control signal that matches that of the supply cable in frequency and voltage level. The command information is modulated on this by omitting individual half waves at a fixed interval.

What are PCM commands needed for?

PCM commands are required to transmit vehicle commands to the control system.

How a PCM command system works

In the PCM command system, different half-wave patterns are transferred to the vehicle control system via PCM system hardware. The control system can detect these commands and adapt its behaviour to them. How the control system responds to a PCM command can be defined in the PCM configuration table.

A PCM command can contain the following information:

- **Function**
 - Binary input
- **Value from speed table**
 - Value range: 1 – 16
 - Index: $[V0]$ – $[V15]$
- **Value from distance table**
 - Value range: 1 – 16
 - Index: $[Dist 0]$ – $[Dist 7]$

Configuration

Function	Configuration (hexadecimal)
Forwards	0x0001 (+ 1)
Backwards	0x0002 (+ 2)
Synchronous	0x0004 (+ 4)
Brake on	0x0008 (+ 8)
Gradient	0x0010 (+ 16)
Slope	0x0020 (+ 32)
Positioning	0x0040 (+ 64)
Special parameter set	0x0080 (+ 128)
Report approach sensor	0x0100 (+ 256)
Approach sensor 1 deactivated	0x0200 (+ 512)
Approach sensor 2 deactivated	0x0400 (+ 1024)
Magnet switch 1 deactivated	0x0800 (+ 2048)
Magnet switch 2 deactivated	0x1000 (+ 4096)
Magnet switch 3 deactivated	0x2000 (+ 8192)
Light sensor 1 deactivated	0x4000 (+ 16384)
Light sensor 2 deactivated	0x8000 (+ 32768)

Tab. 16: PCM commands – Configuration

PCM commands

Standard PCM commands					
PCM command	Function 1	Function 2	Standard configuration	Speed table	Distance table
1	Stopping	-	0x0000	-	-
2	Forwards movement	Normal movement	0x0001	V0	Dist 0
3	Backwards movement		0x0002		

Standard PCM commands

PCM command	Function 1	Function 2	Standard configuration	Speed table	Distance table
4	Forwards movement		0x0001	V1	
5 ¹	Backwards movement <i>Positioning</i>		0x0002		
6	Forwards movement		0x0001	V2	
7	Backwards movement		0x0002		
8	Forwards movement		0x0001	V3	
9	Backwards movement		0x0002		
10	Forwards movement		0x0001	V4	
11	Backwards movement		0x0002		
12	Forwards movement		0x0001	V0	Dist 1
13	Backwards movement		0x0002		
14	Forwards movement <i>Positioning</i>		0x0001	V1	
15	Backwards movement <i>Positioning</i>		0x0002		
16	Forwards movement		0x0001	V2	
17	Backwards movement		0x0002		
18	Forwards movement		0x0001	V3	
19	Backwards movement		0x0002		
20	Forwards movement		0x0001	V4	
21	Backwards movement		0x0002		
22	Forwards movement		0x0001	V0	Dist 2
23	Backwards movement		0x0002		
24	Forwards movement		0x0001	V1	
25	Backwards movement		0x0002		

Standard PCM commands

PCM command	Function 1	Function 2	Standard configuration	Speed table	Distance table
26	Forwards movement		0x0001	V2	
27	Backwards movement		0x0002		
28	Forwards movement		0x0001	V3	
29	Backwards movement		0x0002		
30	Forwards movement		0x0001	V4	
31	Backwards movement		0x0002		
32	Forwards movement		0x0001	V0	Dist 3
33	Backwards movement		0x0002		
34	Forwards movement		0x0001	V1	
35	Backwards movement		0x0002		
36	Forwards movement		0x0001	V2	
37	Backwards movement		0x0002		
38	Forwards movement		0x0001	V3	
39	Backwards movement		0x0002		
40	Forwards movement		0x0001	V4	
41	Backwards movement		0x0002		
42	Forwards movement		0x0001	V0	Dist 4
43	Backwards movement		0x0002		
44	Forwards movement		0x0001	V1	
45	Backwards movement		0x0002		
46	Forwards movement		0x0001	V2	
47	Backwards movement		0x0002		

Standard PCM commands

PCM command	Function 1	Function 2	Standard configuration	Speed table	Distance table
48	Forwards movement		0x0001	V3	
49	Backwards movement		0x0002	V4	
50	Forwards movement		0x0001		
51	Backwards movement		0x0002		
52	Stopping	Open brake	0x0008	-	Dist 0
53	Stopping	-	0x0000		
54	Forwards movement	Ascent	0x0001	V9	
55	Backwards movement		0x0002		
56	Forwards movement	Descent	0x00A1	V10	
57	Backwards movement		0x00A2		
58 ²		Synchronous movement	0x0005	V12+V13 x (PCM-58)	Dist 0
59					
60					
...					
191					

¹ requires additional sensors / ² ↪ 'PCM command '58'' on page 84

Tab. 17: PCM commands



The table values are set in the MU-705 when delivered.



PCM command '58'

PCM command '58' is the first command for the synchronous movement by default. Another command can be configured as the first synchronous command, however.

All commands after the first synchronous command are interpreted as synchronous commands irrespective of their configuration. The speed increment between the commands is calculated automatically.

8.5.2.2 Speed tables – PCM

Speed table

Speed tables allow you to define various speeds, which are accessed by the vehicle control system. Access to the individual speeds in this table is gained via an index. This is defined depending on the type of application or can be set through the PCM configuration table. This allows various speeds to be specified, for example, for various sectors in a plant.

Speed (16×4 byte)

Unit: mm/min

No.	Index	Explanation / application area	Value
1	V0		Parameter
2	V1		
3	V2		
4	V3		
5	V4	Positioning switch / FR-85	
6	V5	Speed limiting when triggering magnet switch 1	
7	V6	Speed limiting when triggering magnet switch 2	
8	V7	Speed limiting when triggering magnet switch 3	
9	V8	Slow movement after waiting time after triggering the approach sensor	
10	V9	Speed limiting when triggering light sensor 1	
11	V10	Speed limiting when triggering light sensor 2	
12	V11	Minimum speed	
13	V12	Synchronous speed, basic value	
14	V13	Synchronous speed, additive	
15	V14	Manual mode, slow movement	
16	V15	Manual mode, fast movement	

Tab. 18: Speed table – PCM

8.5.2.3 Distance table – PCM

Distance table

In order to avoid vehicle collisions (distance control), it is possible to define various distances in the distance tables, which are then accessed by the vehicle control system. Access to the individual distances is gained via an index. This is defined depending on the type of application or can be set through the PCM configuration table. Thanks to the variable configuration of a distance sensor, it is possible to implement various distances.



Unit:	mm		
No.	Index	Explanation / application area *	Value
1	Dist 0	A	See system documentation
2		B	
3	Dist 1	A	
4		B	
5	Dist 2	A	
6		B	
7	Dist 3	A	
8		B	
9	Dist 4	A	
10		B	
11	Dist 5	A	
12		B	
13	Dist 6	A	
14		B	
15	Dist 7	A	
16		B	
* Explanation / application area			
A	After undershooting the defined distance (value) to the next vehicle the vehicle moves on at the speed defined in [V5]		
B	After undershooting the defined distance (value) to the next vehicle the vehicle stops		

Tab. 19: Distance table – PCM

8.5.2.4 Creating and saving vehicle tables

Vehicle tables are edited and saved in the MU-705 manual programming device and in the MU-705 utility software.

Editing and saving tables with the MU-705 manual programming device:

1.  Open menu item "Tables" → "...table" → "Modify tab."
2.  Edit table.
3.  Press ESC to exit menu item.
 - ⇒ Modifications to the table are stored in the MU-705 manual programming device



Editing individual table entries

If only individual table entries of a pre-configured vehicle control system have to be adjusted as part of system optimisation, it is recommended to read and archive the tables from the vehicle control system prior to modification. This ensures that the values in the MU-705 manual programming device match those in the vehicle control system.



NOTICE!

Regular data backups

Property damage may result from data losses.

- Regularly perform backups of your data onto a separate computer.
- For backups on a PC, it is recommended to use the MU-705 Utility program.

8.5.2.5 Transferring vehicle tables

Vehicle tables are transferred to the vehicle control system using the MU-705 manual programming device.



Vehicle tables

Vehicle tables can be transferred individually or all together!

Transferring an individual table with the MU-705 manual programming device:

1. ➤ Open menu item "Tables" → "...table" → "Write tab."
2. ➤ Press the F1 key [Yes] to confirm the 'Send' request.
3. ➤ Establish infrared communication.
 - ⇒ The selected table is transferred from the MU-705 manual programming device to the vehicle control system.

Transferring all tables with the MU-705 manual programming device:

1. ➤ Open menu item "Tables" → "All tables" → "Write".
2. ➤ Press the F1 key [Yes] to confirm the 'Send' request.
3. ➤ Establish infrared communication.
 - ⇒ All tables are transferred from the MU-705 manual programming device to the vehicle control system.

8.5.3 Vehicle tables – Rail bus

Vehicle tables contain data, which is accessed by certain control system functions. This data is assigned to the system in which the vehicle control system is used.

Values are defined in the vehicle tables which relate to motion and positioning functions.

These tables are:

- Segment tables
- Speed tables
- Distance tables
- Stop-offset tables



NOTICE!

Table values as per checked system documentation

For fault-free operation of the vehicles, the table values must be checked using the system documentation.

8.5.3.1 Segment table – Rail bus

Segment table

The segment table is the image of a system/ system section. In order to be able to define control system behaviour in different subsections of the system, the system is divided into segments based on the position value. The control system behaviour – e.g. speed, distance, positioning, etc. – can be configured in this table for each segment.

Segment table (60×4 byte)

In the segment table, segments are identified by their index, their start and end positions, and the values assigned to the individual segments.

Structures of the table for TCU and DKZ:

DKZ (15 entries (lines) per table)

Field	PosPnt	control1	dest2	vel1	vel2	vel3	dist
Bits	16	8	8	4	2	2	4
0							
...							
14							

DKZ (15 entries (lines) per table)

Field	dest3	start	end	prev1	prev2	next1	next2
Bits	4	24	24	8	8	8	8
0							
...							
14							

TCU (12 entries (lines) per table)

Field	PosPnt	start	end	prev1	prev2	prev3	next1	next2	next3
Bits	16	24	24	8	8	8	8	8	8
0									
...									
11									

TCU (12 entries (lines) per table)

Field	dest2	dest3	vel1	dist	vel2	vel3	control1	control2
Bits	8	8	4	4	4	4	8	8
0								
...								
11								

Field	Explanation	DKZ	TCU
control1	Control flags	✓	✓
control2	Control flags		✓
dest2	Axis 2 index	✓	✓
dest3	Axis 3 index	✓	✓
dist	Distance index	✓	✓
end	End position of the segment	✓	✓
next1	1st Successor of the segment	✓	✓
next2	2nd Successor of the segment	✓	✓
next3	3rd Successor of the segment		✓
posPnt	Position point	✓	✓
prev1	1st Predecessor of the segment	✓	✓
prev2	2nd Predecessor of the segment	✓	✓
prev3	3rd Predecessor of the segment		✓
start	Start position of the segment	✓	✓

STB_0004, 10, en_GB

Field	Explanation	DKZ	TCU
vel1	Axis 1 speed	✓	✓
vel2	Axis 2 speed	✓	✓
vel3	Axis 3 speed	✓	✓

8.5.3.2 Speed table – Rail bus

Speed table

Speed tables allow you to define various speeds, which are accessed by the vehicle control system. Access to the individual speeds in this table is gained via an index. This is defined depending on the type of application or can be set through the segment table. The segment table defines which speed index applies for which system segment. Based on the system position, the vehicle control system identifies the current segment and proceeds at the specified speed. This allows the specification of various speeds for cornering, straight travel, etc.

Asynchronous speed (16X4 byte)

Unit: | mm/min

No.	MU index	SyMa/DKZ	Explanation / application area	Value
1		0		See system documentation
2		1		
3		2		
4		3		
5		4		
6		5		
7		6		
8		7		
9		8	Slow movement after waiting time after triggering the approach sensor	
10		9		
11		10	Maximum asynchronous speed	
12		11	Minimum speed	
13		12	Set-up mode, slow movement	
14		13	Set-up mode, fast movement	
15		14	Manual mode, slow movement	
16		15	Manual mode, fast movement	

Tab. 20: Speed table – Rail bus – Asynchronous

Synchronous speed (16×4 byte)

Unit: | mm/min

No.	MU index	SyMa/DKZ	Explanation / application area	Value
1		0		
2		1		
3		2		
4		3		
5		4		
6		5		
7		6		
8		7		See system documentation
9		8		
10		9		
11		10	Maximum synchronous speed	
12		11		
13		12		
14		13		
15		14		
16		15		

Tab. 21: Speed table – Rail bus – Synchronous

8.5.3.3 Distance table – Rail bus**Distance table**

Distance tables allow you to define various distances, which are accessed by the vehicle control system. Access to the individual distances is gained via an index. This is defined depending on the type of application or can be set through the segment table. The segment table defines which distance index applies for which system segment. Based on the system position, the vehicle control system identifies the current segment and maintains the set distance to the preceding vehicle. This allows the specification of distances, such as the ones related to buffer zones, bends, etc.

Distance table (16×2 byte)

Unit: | mm

No.	Index	Explanation / application area	Value
1	0		Parameter
2	1		
3	2		
4	3		
5	4		
6	5		
7	6		
8	7		
9	8		
10	9		
11	10		
12	11		
13	12		
14	13		
15	14		
16	15		

Tab. 22: Distance table – Rail bus



Values can be negative.

8.5.3.4 Stop-offset table

Stop-offset table

A fixed stop point is defined in the segment table during positioning. With the help of the stop-offset table, the vehicle can stop earlier by a particular value defined in the table. Access to the individual stop-offset is gained via an index. The stop-offset index to be used is specified directly by the system controls. This, for instance, allows a vehicle to be positioned according to its load.

Stop offset (3 x 2 byte), unit in mm

Number	Index	Explanation / application area
0	0	
1	1	

Number	Index	Explanation / application area
2	2	

Tab. 23: Stop offset – Rail bus

8.5.3.5 Creating and saving vehicle tables

Vehicle tables are edited and saved in the MU-705 manual programming device and in the MU-705 utility software.

Editing and saving tables with the MU-705 manual programming device:

1. ➤ Open menu item "Tables" → "...table" → "Modify tab."
2. ➤ Edit table.
3. ➤ Press ESC to exit menu item.
 - ⇒ Modifications to the table are stored in the MU-705 manual programming device



Editing individual table entries

If only individual table entries of a pre-configured vehicle control system have to be adjusted as part of system optimisation, it is recommended to read and archive the tables from the vehicle control system prior to modification. This ensures that the values in the MU-705 manual programming device match those in the vehicle control system.



NOTICE!

Regular data backups

Property damage may result from data losses.

- Regularly perform backups of your data onto a separate computer.
- For backups on a PC, it is recommended to use the MU-705 Utility program.



Rail bus projects

In rail bus projects, it is also possible to edit, save and transfer parameters, configuration switches and tables to the vehicle control system using the iDM-SyMa (iDM system) or DKZ-Para (bus master system).

Requirement: properly configured iDM system or bus master system

8.5.3.6 Transferring vehicle tables

Vehicle tables are transferred to the vehicle control system using the MU-705 manual programming device.



Vehicle tables

Vehicle tables can be transferred individually or all together!

Transferring an individual table with the MU-705 manual programming device:

1. ➤ Open menu item "Tables" → "...table" → "Write tab."
2. ➤ Press the F1 key [Yes] to confirm the 'Send' request.
3. ➤ Establish infrared communication.
 - ⇒ The selected table is transferred from the MU-705 manual programming device to the vehicle control system.

Transferring all tables with the MU-705 manual programming device:

1. ➤ Open menu item "Tables" → "All tables" → "Write".
2. ➤ Press the F1 key [Yes] to confirm the 'Send' request.
3. ➤ Establish infrared communication.
 - ⇒ All tables are transferred from the MU-705 manual programming device to the vehicle control system.



Rail bus projects

In rail bus projects, it is also possible to edit, save and transfer parameters, configuration switches and tables to the vehicle control system using the iDM-SyMa (iDM system) or DKZ-Para (bus master system).

Requirement: properly configured iDM system or bus master system

8.6 Configuring the bus communication (ST-87x-SB/ST-88x-SB)

In order for the vehicle control system to be able to communicate with the iDM system or the bus master system via the rail bus and thus with the PLC, the bus communication must be configured properly.

8.6.1 Configuration

Settings for iDM-SyMa (system manager)

Data length

Package type (commands)	Short (2 bytes)
Extended lengths (commands)	0 bytes
Package type (status)	Short (2 bytes + 3 bytes motion position)
Extended length (Status)	0 bytes

Communication

Byte sequence (header) PLC ↔ MCU	H/L (big endian)
Baud rate TCU ↔ Vehicle	Configurable Following baud rates (bit/s) are possible: <ul style="list-style-type: none"> ■ 31250 ■ 46875 ■ 62500 ■ 125000

8.6.2 Instructions

Bit	Meaning	
2 ⁰	Coupling segment	This bit shows that the segment borders another bus master segment (TCU/DKZ).
2 ¹	Movement without code	This bit shows that the segment has no code strip. Corresponding errors are deactivated.
2 ²	Descent	These bits are used for switching to the 'move backwards' parameter sets.
2 ³	Ascent	These bits are used for switching to the 'move forwards' parameter sets.
2 ⁴	Close gaps	For a synchronous drive, the vehicle moves quicker to close the gap to the vehicle in front.
2 ⁵	Synchronous movement	By setting this bit, the vehicle controls the motor control system to reach the precise reference speed.
2 ⁶	Stop at the end of the segment	By setting this bit, the vehicle stops at the end of the segment.

Bit	Meaning	
2 ⁷	Stop in segment centre	By setting this bit, the vehicle stops in the centre of the segment.
2 ⁸	Distance check	By setting this bit, the vehicle controls the speed to reach the precise reference distance to the vehicle in front.
2 ⁹	Special movement	This bit is used for switching to the special movement parameter set.
2 ¹⁰	-	
2 ¹¹	-	
2 ¹²	-	
2 ¹³	-	
2 ¹⁴	-	
2 ¹⁵	-	

8.6.3 Cyclical telegrams

In rail bus systems with iDM or DKZ system.

Cyclical telegrams are used to transmit commands to the vehicle and status information to the bus master (DKZ/TCU), and from there on to the PLC.

Use and arrangement of individual command and status bits can vary between TCU and DKZ.

- Command A
- Command B

PLC command

Command A

Bit	TCU meaning	DKZ meaning
2 ⁰	-	Bit 0 stop offset selection
2 ¹	-	Bit 1 stop offset selection
2 ²	Bypass position	Bypass position
2 ³	Error reset	Output 1
2 ⁴	Release brake	Output 2
2 ⁵	Bit 0 stop offset selection	Release drive
2 ⁶	Bit 1 stop offset selection	-
2 ⁷	Automatic mode	Automatic mode

Command B

Bit	TCU meaning	DKZ meaning
2 ⁰	Forwards movement	Forwards movement
2 ¹	Backwards movement	Backwards movement
2 ²	-	-
2 ³	-	-
2 ⁴	Faster set-up mode	Faster set-up mode
2 ⁵	Release brake	Release brake
2 ⁶	Output 1	Error reset
2 ⁷	Output 2	-

PLC status**Status A**

Bit	TCU meaning	DKZ meaning
2 ⁰	Change table	Change table
2 ¹	Toggle bit, if a target position has been received	Toggle bit, if a target position has been received
2 ²	Vehicle in position	Vehicle in position
2 ³	Stop through distance check	Toggle bit, if a vehicle type has been received
2 ⁴	Toggle bit, if a vehicle type has been received	Error
2 ⁵	Stop through stop switch	Automatic mode (inverted)
2 ⁶	Error	No communication
2 ⁷	Automatic mode (inverted)	-

Status B

Bit	TCU meaning	DKZ meaning
2 ⁰	-	Used
2 ¹	-	Used
2 ²	-	Used
2 ³	-	Used
2 ⁴	Stop through approach sensor	Used
2 ⁵	Vehicle in motion	-
2 ⁶	Input 1 status	Input 1 status
2 ⁷	Input 2 status	Input 2 status

8.6.4 Acyclic telegrams

In rail bus systems with iDM or DKZ system.

The vehicle is defined by the vehicle number specified in byte 22-23 of the acyclic data frame.

Index	Type	Data length	Valid for:
0x31	R/W	0/2	Vehicle type
0x32			
0x33	W	0	Error reset
0x34	R	5	Diagnostics 1
0x35	W	0	Diagnostics 1 reset
0x36			
0x37			
0x38	R	10	Diagnostics 2
0x39	R	4-240	Error log
0x3A	W	2/4	Target index / position
0x3B			
0x3C			
0x3D			
0x3E			
0x3F	R/W	1-240	Vehicle-related data

Index 0x31 – Vehicle type

The vehicle type can be set or read through this function.

Byte		Meaning
0	LB	Vehicle type
1	HB	

Index 0x33 – Error reset

By writing this index with the length = 0, the error status in the vehicle can be reset.

Index 0x34 – Diagnostics 1 (statistics)

Statistical diagnostics data can be read from the vehicle through this function. These are defined by the vehicle number.

The diagnostics data contains information on the maximum and average motor current. It also includes information on the maximum temperature.

Byte	+0	+1	Meaning
0	HB maximum current	LB maximum current	Drive
2	HB average current	LB average current	
4	Maximum temperature		

Index 0x35 – Diagnose 1 reset

By writing this index with the length = 0, the diagnostics data in the vehicle can be reset.

Index 0x38 – Diagnostics 2 (current statistics)

Through this function, statistical data can be read from the vehicle for a diagnosis. The vehicle number clearly defines which vehicle the data came from. The diagnostics data contains information on the current vehicle status.

Byte	+0	+1	+2	Meaning
0	MB movement position	HB movement position	LB movement position	Current position
3	Converter temperature			Current converter temperature
4	HB motor frequency	LB motor frequency		Current converter or motor frequency
6	HB motor current	LB motor current		Current motor current
8	In K20			Status of the K20 inputs
9	Out K20			Status of the K20 outputs

Index 0x39 – Error log

If an error occurs in the vehicle, the error number, TCU number and 2 bytes on the drive position are saved in a log buffer. The error log buffer can be read through this function. The length of the buffer depends on the quantity of errors. If no entry is available, 4 zeros are sent. A maximum of 60 errors can be saved to the error log buffer. Once the error log is read, the buffer is deleted.

Byte	+0	+1	+2	+3	Meaning
0	Error number	TCU No.	HB position	LB position	Last error
4	Error number	TCU No.	HB position	LB position	Error 2
.					
236	Error number	TCU No.	HB position	LB position	Error 60

**Index 0x3A –
Target index /
position**

The target index / position can be written to the vehicle with this function.

Byte		Meaning
0	HB	Destination index
1	LB	

Byte		Meaning
0	TB	Target position
1	MB	
2	HB	
3	LB	

**Index 0x3F –
Vehicle-related
data**

Vehicle-related data can be written in every vehicle with this function. The data are saved in the vehicle and can be read as an when required.

Vehicle-related data can be written to the control system and read again. Even if the control system is without current, the data is retained. The data has no influence on the behaviour of the control system.

**Vehicle and
system tables**

Index		Length	Meaning
MCU	Vehicle		
0x10	0x50	188(210F ¹)	Block 1, Parameter 1
0x11	0x51	0	Block 2, Parameter 2
0x12	0x52	64	Block 3, asynchronous speed
0x13	0x53	0-240	Block 4, common table
0x14	0x54	32	Block 5, distance
0x15	0x55	240	Block 6, target
0x16	0x56	0-240	Block 7, common table
0x17	0x57	0-240	Block 8, common table
0x18	0x58	0-240	Block 9, common table
0x19	0x59	0-240	Block 10, common table
0x1A	0x5A	0-240	Block 11, common table
0x1B	0x5B	0-240	Block 12, common table

Index		Length	Meaning
MCU	Vehicle		
0x1C	0x5C	0-240	Block 13, common table
0x1D	0x5D	0-240	Block 14, common table
0x1E	0x5E	0-240	Block 15, common table
0x1F	0x5F	0-240	Block 16, common table
0x20	0x60	0-240	Block 17, common table
0x21	0x61	0-240	Block 18, common table
0x22	0x62	0-240	Block 19, common table
0x23	0x63	64	Block 20, synchronous speed
0x24	0x64	240	Block 21, segment table, block 1
0x25	0x65	240	Block 22, segment table, block 2
0x26	0x66	240	Block 23, segment table, block 3
0x27	0x67	240	Block 24, segment table, block 4
0x28	0x68	240	Block 25, segment table, block 5
0x29	0x69	240	Block 26, segment table, block 6
0x2A	0x6A	0-240	Block 27, indexed table ²
0x2B	0x6B	0-240	Block 28, indexed table ²
0x2C	0x6C	0-240	Block 29, indexed table ³
0x2D	0x6D	0-240	Block 30, indexed table ³
0x2E	0x6E	0-240	Block 31, indexed table ³
0x2F	0x6F	6	Block 32, stop offset ³



¹ Quantity of parameter data in field-oriented mode

² Depends on the TCU area / DKZ area

³ Depends on the vehicle type

8.7 Test control system

The following parameters can be tested after parameter assignment:

-  Chapter 'Test – motor functions' on page 102
-  Chapter 'Test – Sensors and peripherals' on page 103
-  Chapter 'Test – Communication' on page 104

8.7.1 Test – motor functions



WARNING!

Unchecked parameter values

Unchecked parameter values can lead to uncontrolled drive movements.

- Decouple gear system before first test.

Motor function test

When testing the motor function, the mechanical and electrical function and the correct parameter assignment of the drivetrain are checked.

To give brief commands to the control system, using the remote control is recommended. For the control system to respond to the commands of the remote control, the control system must be in manual mode.



Activating manual mode with the remote control

Manual mode is activated by pressing the star button  of the remote control. Manual operating mode is displayed in the control system by the blue LED flashing once or twice.

Motor rotation test

To test motor rotation, a motion command is transmitted to the control system using the remote control.





NOTICE!

High motor speed

Damage to the motor and gear system

- For the initial start-up, a slow manual speed (e.g. 5,000 mm/min) should be selected. This is set under V14 of the speed table (asynchronous).

1. ➤ Press right direction button 
 - ⇒ Opens mechanical brake (if available)
 - Motor rotates
2. ➤ Press left direction button 
 - ⇒ Opens mechanical brake (if available)
 - Motor rotates





During the test make sure that:

- *The motor is rotating in the specified direction.*
- *The rated current is not exceeded.*
- *The motor overrun is quiet.*

Brake test

If the motor used has a mechanical brake, this can be opened regardless of the rotation of the motor shaft. To test the brake, an "Open brake" command is transmitted to the control system using the remote control.

- Hold down the star  and arrow-up  buttons simultaneously
 - ⇒ When the brake is opened an audible click will be heard.

Motor temperature sensor test

If the connected motor(s) is/are equipped with a temperature sensor, you can test whether it is working or not. You can check whether the control system is reading a valid temperature/resistance value in **display mode 6** (motor temperature).

🔗 *Chapter 'Display modes' on page 118*



Temperature monitoring can be deactivated through the set configuration switch [SW16].

If the control system cannot read any values, excess temperature error [F114] is displayed. Possible causes:

- Wiring fault
- No temperature sensor installed or connected

8.7.2 Test – Sensors and peripherals

Binary input test

Switching states of the connected components can be displayed and checked using the **display mode 040** (I/O card inputs). Each activated input of the I/O card sets a defined bit in the display value.

By setting or deleting an input bit, the value in the display can be checked.

↪ Chapter 'Display modes' on page 118

Binary output test

The **Display mode 041 (I/O card outputs)** can be used to check the switching states of the I/O card outputs. Outputs are set in a test-like manner using the parameter "Output test – Configuration" [CTsO].

For outputs to be activated in this way, the control system must be in unrestrained manual mode (configuration switch [SW12]).

For the output test, the relevant bit must be set in the parameter "Output test – Configuration" [CTsO] and the switch status checked in **display mode 41** (I/O card outputs) and on the corresponding output component.

↪ Chapter 'Display modes' on page 118

Bus components test

Position encoders, distance sensors and vehicle address boxes can be used as bus components. The bus components must support the LJU bus protocol.



The relevant component must be selected (parameter "Input X16– Configuration" [C116]) and connected to the control system [X16].

If the bus components are properly connected and configured, values are displayed in the relevant display modes.

Display mode 036 (Encoder position – unfiltered [mm]):
Position encoder = Position value

Display mode 038 (Current distance encoder value [mm]):
Distance sensor = Distance value

Display mode 080 (Vehicle number):
Vehicle address box = Vehicle number

If the connection cable between the control system and bus component is removed, an offline error must appear.

↪ Chapter 'Display modes' on page 118

8.7.3 Test – Communication

PCM commands / messages

Requirement for the automatic operation of the vehicle is the detection and processing of commands. You can check whether or not these arrive correctly at the control system via **display mode 050** (PCM command). This displays the incoming PCM command as a decimal value.

If **Z-stop** is used, the signal detection on the control system must be tested. A Z-stop signal is placed on the relevant rail by a vehicle in the successor segment. Only the signal input can be checked in **display mode 053** (Z stop). Since the Z-stop signal is a full wave, 202 must be shown in the display.

The transmission of messages to the signal rail is important as feedback for system control. Depending on the configuration, the relevant control system statuses (error status, manual mode, positioned, etc.) must be established for this to occur. The messages can be checked on the system PLC or using the LED statuses on the PCM input module.

Rail bus communication



In the case of vehicle control systems with rail bus communication, commands and messages are exchanged through the rail bus. To test this, the control system must be registered on the TCU or bus master.

In addition to correct wiring and parameter configuration, a requirement for registration is the existence of a valid position value ($\neq 0$) as well as a valid vehicle number ($\neq 0$).

Communication is successful if the control system can be registered.

As an additional control option, it is possible to compare the command and status words of the TCU or bus master and the control system using **display mode 120** (PLC command A + B) and **display mode 121** (PLC status A + B).

8.8 Optimise settings

Motor settings

Motor parameter optimisation follows two opposing objectives.

- The motor current should be as low as possible so that the motor does not overheat and consumes little power.
- The motor should have sufficient force to move the vehicle and its load safely and reliably at all times.

When the motor has correct parameter assignment in the parameters "Motor – Rated current" [*In1*], "Motor – Stator resistance" [*Rs1*] and "cut-off frequency" [*Fn1x*], the motor is essentially well configured. The current consumption can be varied with the "IXR compensation factor" [*IR1x*] for low to medium frequencies.



NOTICE!

Higher rated current

Excessive rated current may lead to motor overload!

- The rated current should only be exceeded for large loads; e.g. when braking and accelerating, as well as ascending and descending movements.

Brake and acceleration ramps

When setting the parameters for braking and accelerating ramps in the respective movement modes (normal movement, ascent, descent, synchronous movement, special movement), the best of two opposing target settings must be found.

- Steep ramps
 - Quick accelerating and braking.
 - High wear due to high mechanical loads.
- Gentle ramps
 - Slow accelerating and braking.
 - Low wear due to light mechanical loads.

Configuration with jerk limiting (parameter "Jerk limit – Configuration" [*Cj_*]) enables gentle acceleration and braking.

Frequency for opening and closing the brake

The frequency should be selected low wherever possible, since starting against a closed brake will result in mechanical load and high motor current.

Settings are made in the parameters of the modes of movement (normal movement, ascent, descent, synchronous movement, special movement).

***Increase frequency for opening and closing the brake***

This frequency can be raised in ascending and descending movements to prevent the vehicle from rolling forwards or backwards unintentionally.

Time delays

If an old control system has to be replaced with a ST-87x / ST-88x, one notices that it often responds more quickly to input signals (PCM and component inputs). To compensate for this time shift, delay times can be set for commands with the parameters "PCM command – Command change delay" [*TPc0*] and [*TPc*] and for components with the parameter "Detection delay time" [*TDxx*].

9 Operation

Objective	This section explains the work steps required by the operator.
In daily operation	<p>In daily operation the system is used in automated fashion, so that:</p> <ul style="list-style-type: none"> ■ The safety of personnel is ensured. ■ Workflows and functions are monitored using control system technology. ■ Trained users are supported in ongoing processes at regular intervals.
Responsible party	<p>The operator, or supervisory personnel appointed by him, is responsible for a safe and seamless workflow. As the contact person, he responds to all the personnel's queries regarding safe-to-use equipment; e.g.:</p> <ul style="list-style-type: none"> ■ Fire protection ■ Electrical equipment
Required personnel	<p>Due to their training and experience, only qualified and appropriately instructed personnel are able to correctly assess the respective initial situation, identify risks and avoid hazards.</p> <p>Personnel required for everyday operation:</p> <ul style="list-style-type: none"> ■ Qualified and appropriately instructed operating personnel ■ Qualified and appropriately instructed maintenance personnel
Required personal protective equipment	<p>The person responsible must ensure that the personnel under his responsibility are wearing the required personal protective equipment. The required personal protective equipment satisfies the requirements for the work to be carried out and all the requirements demanded by the scope of work.</p> <p>Personal protective equipment that fulfils its intended purpose:</p> <ul style="list-style-type: none"> ■ protects its wearer from injury; ■ reduces the seriousness and severity of potential injuries. <p>Wear:</p> <ul style="list-style-type: none"> ■ Work protection clothing ■ Safety shoes ■ Protective gloves ■ Protective goggles
Safety in the work area	<ul style="list-style-type: none"> ■ Only work when protection and monitoring equipment are active. ■ Pay attention to the safety signs at the work station and its immediate vicinity. ■ Only load load-bearing machinery within the permitted limits. ■ Secure goods to be transported against loss.



Work safety

Pay attention to company and task-specific work safety regulations, as well as the country-specific legal and safety regulations applicable at the location of use.



Wear additional protective equipment

As an employee, you wear protective equipment supplied by the area supervisor. If work tasks have been delegated only temporarily, then you also wear any protective equipment that has become additionally required.

Special hazards



⚠ WARNING!

Automatic start-up

Danger posed by unintended activation of the control system and start-up of motors and drive units.

Risk of crushing limbs, catching and dragging of loose items of clothing due to moving machine parts

- No persons in the danger zone of moving system parts
- Deactivate automatic start-up
- Only activate control system under supervision
- If necessary, disengage the drive.
- If necessary, disconnect the vehicle from voltage.
- Keep clear of moving system parts.
- Do not reach into the running machine.
- Wear tight-fitting work clothes.
- Pay attention to optical and acoustic warning equipment.



⚠ WARNING!

Hazardous voltages on ports and cables

Open electrical components

- Do not pull plugs carrying voltage.
- Do not contact open cables.



⚠ WARNING!

Start/stop switch

The start/stop switch does not disconnect the controller from the power supply. Dangerous voltage is present.

- Installation of a main switch by the system operator or system manufacturer.
- All poles of the power supply must be able to be switched off and protected against being switched on again.
- The control system must be disconnected from the power supply when performing work on it.



⚠ WARNING!

Risk of fire due to hot surfaces

Highly flammable materials may catch fire if they come in direct or indirect contact with the hot surfaces of the device.

- Ensure that the air around the device is constantly circulated.
- Do not place any flammable materials on top of the device.
- Keep flammable materials away from the housing surface and the heat sink.



⚠ CAUTION!

Hot surfaces

Risk of burns posed by hot surfaces of the control system and connected components.

- Install protective equipment and check it regularly.
- Prior to working on the control system, allow the connected components to cool down.

9.1 Operating modes

Operating modes

The control system can be operated in the following ways:

- Automatic mode
- Manual mode
- Unrestrained manual mode

Automatic mode

In automatic mode, the control system responds to PCM or rail bus commands of the higher-level system controller, or the control system works through an internally defined motion program. In the event of faults, the control system stops.

Manual mode

The control system can be operated via the remote control in manual mode. Errors are only evaluated to a limited degree in manual mode. When switching to manual mode or back to automatic mode, any present errors are reset. If the cause of the problem continues to exist, however, then the relevant message appears on the display.

Unrestrained manual mode

In unrestrained manual mode, it is possible to operate the control system despite faults being present. The control system responds exclusively to converter, data bus and communication errors. Software restrictions set through parameters are taken out of action in this operating mode. Hardware-induced restrictions remain in place.

9.2 Switching the control system on and off**9.2.1 Switch on control system****Automatic start-up**

- After activation, the control system goes into automatic mode autonomously

➔ Set start/stop switch to [I]

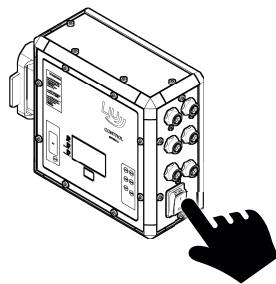

⇒ The control system starts.

Display during activation

After switching on, the display shows the "Conductix" logo during the start delay period.

The start delay is set in parameter [T0].



Fig. 17: Display during activation

9.2.2 Switches the control system off

➔ Set start/stop switch to [0]

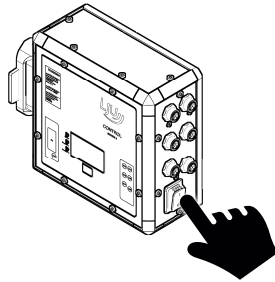

Display during shutdown

If the control system is switched off, the display shows the inverted "Conductix" logo.



Fig. 18: Display during shutdown

9.3 Displays

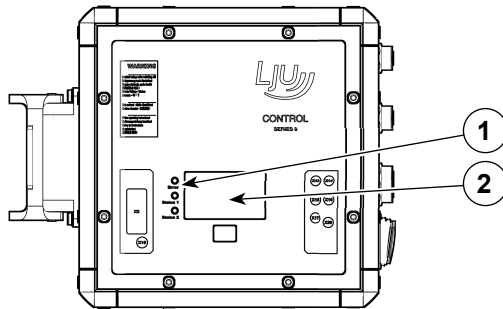

- 1 Status LEDs
- 2 Display

9.3.1 Status LEDs

- LED – Error
- LED – Status 1
- LED – Status 2



Status LEDs for PCM and rail bus communication

The meaning of LEDs differs depending on communication version of the vehicle control system.

- Pulse Code Modulation (PCM)
- Rail bus communication (SB)

LED – Error

Message	Meaning	SB	PCM
Off 	Control system is fault-free	✓	✓
On - Lights up permanently 	Control system is in automatic mode and no vehicle was found	✓	
Flashing - LED flashes (on/off each time approx. 1 sec) 	Control system has errors	✓	✓
Single flash - LED flashes once 	Stop activated	✓	✓

Tab. 24: Display – LED – Error

LED – Status 1

Message	Meaning	SB	PCM
Off ○	No meaning		
On - Lights up permanently ●	PCM command present and axis is driven		✓
Flashing - LED flashes (on/off each time approx. 1 sec) ⚡○ ⚡○	PCM command present		✓
Single flash - LED flashes once ⚡○ ⚡○	Control system is in manual mode	✓	✓
Double flash - LED flashes twice ⚡⚡○ ⚡⚡○	Control system is in unrestrained manual mode	✓	✓

Tab. 25: Display – LED – Status 1

LED – Status 2

Message	Meaning	SB	PCM
Off ○	No meaning		
On - Lights up permanently ●	Vehicle position is positioned and standing	✓	✓
Flashing - LED flashes (on/off each time approx. 1 sec) ⚡○ ⚡○	Vehicle stops – Z-stop		✓
	Vehicle stops – Distance check	✓	
Single flash - LED flashes once ⚡○ ⚡○	Vehicle stops – Approach sensor	✓	✓
Double flash - LED flashes twice ⚡⚡○ ⚡⚡○	Vehicle stops – Distance sensor	✓	✓

Tab. 26: Display – LED – Status 2

STB_0004, 10, en_GB

9.3.2 Display

Display during activation

After switching on, the display shows the "Conductix" logo during the start delay period.

The start delay is set in parameter $[T0]$.



Fig. 19: Display during activation

Display during shutdown

If the control system is switched off, the display shows the inverted "Conductix" logo.



Fig. 20: Display during shutdown

Display layout

The display can be toggled:

- Display layout – **Standard**
- Display layout – **Extended**

The display layout can be switched between standard and extended by setting the $[SW1]$ configuration switch in the manual programming device.

Display presentation – Standard

Four lines each with the number of the display mode and its value are shown on the display by default. Which values are displayed can be configured.

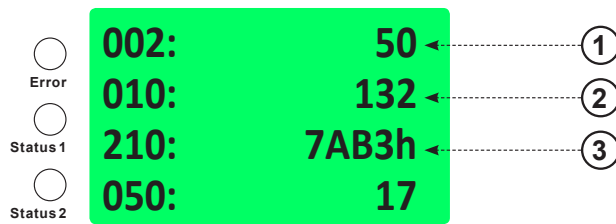

Fig. 21: Display – Standard presentation

- 1 Display mode **002** – Target speed: 50 mm/min
- 2 Display mode **010** – Stopping distance from actual speed: 132 mm
- 3 Display mode **210** – Debug area (relevant for the service team): hexadecimal display

Display presentation – Extended

An individual display value can be presented in large digits for better legibility from long distances. In a second line, the unit and the number of the displayed value are shown in a smaller size type.

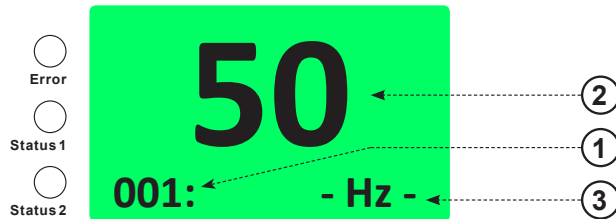

Fig. 22: Display – Extended layout

- 1 Display mode
- 2 Value
- 3 Unit

Infra-red communication

In the case of infra-red communication, the presentation on the display is inverted.



Fig. 23: Display during infra-red communication

Fault indicator

If the vehicle is in error mode, the error number and a red LED flash. Error number and error message are shown in alternation.

If more than one error is active, the various numbers and messages are displayed one after the other.

The error number is composed of a large "F" and a three-digit hexadecimal number.

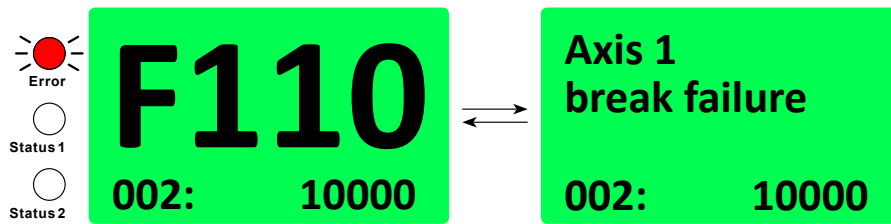

Fig. 24: Display – Error message



Fault indicator can be deactivated through configuration switch [SW13].

9.3.3 Display modes

The display mode refers to the numbering of the respective status information shown in the display. The display can be configured using the numbering.

(e.g.: Display mode 002 shows the set speed)

values are shown in **decimal** or **hexadecimal** format.

- Decimal values can be read directly.
- Hexadecimal values are indicated by a "h" behind the value and must be converted for calculation.

If multiple lines of the legend apply, the bits are added. ↪ Chapter 'Calculating and evaluating hexadecimal values' on page 140

The following values can be displayed on the display.

Display mode	Meaning	dec.	hex.
000	Target electrical frequency [Hz]	×	
001	Actual electrical frequency [Hz]	×	
002	Target speed [mm/min]	×	
003	Actual speed [mm/min]	×	
004	CPU temperature [°C]	×	
005	DC link voltage [V]	×	
006	Motor temperature [°C]	×	
007	Motor power [mW]	×	

Display mode	Meaning	dec.	hex.
008	Control word		×
009	Stopping distance from target speed [mm]	×	
010	Stopping distance from actual speed [mm]	×	
011	Inverter status		×
012	Additional status information	×	
013	Error word 0		×
014	Error word 1		×
015	Error word 2		×
018	Controller position [mm]	×	
019	Control system software version	×	
020	Current parameter sets "motor" (ten's digit) and "motion" (unit's digit)	×	
025	Movement enabling		×
026	Internal control commands		×
027	Hidden components		×
028	Motor voltage [V]	×	
029	Motor current [mA]	×	
030	Heat sink temperature [°C]	×	
032	Error word parameter identification		×
035	Position encoder status	×	
036	Encoder position - unfiltered [mm]	×	
037	Encoder position - filtered [mm]	×	
038	Current distance encoder value [mm]	×	
039	Distance encoder distance index	×	
040	I/O card inputs		×
041	I/O card outputs		×
050	PCM command	×	
051	IR command	×	
053	Z-stop	×	
054	GET [mm]	×	
055	Relay status notification		×
057	Number of motor pole pairs	×	
060	Internal command	×	

Display mode	Meaning	dec.	hex.
080	Vehicle number	X	
081	Vehicle type	X	
090	FCS block 1 rotated + not rotated	X	
091	FCS block 2 rotated + not rotated	X	
092	FCS block 3 rotated + not rotated	X	
093	FCS block 4 rotated + not rotated	X	
094	FCS block 5 rotated + not rotated	X	
095	FCS block 6 rotated + not rotated	X	
096	FCS block 7 rotated + not rotated	X	
097	FCS block 8 rotated + not rotated	X	
098	FCS block 9 rotated + not rotated	X	
099	FCS block 10 rotated + not rotated	X	
100	FCS block 11 rotated + not rotated	X	
101	FCS block 12 rotated + not rotated	X	
102	FCS block 13 rotated + not rotated	X	
103	FCS block 14 replace + rotated + not rotated	X	
104	FCS block 15 replace + rotated + not rotated	X	
105	FCS block 16 replace + rotated + not rotated	X	
106	FCS block 17 replace + rotated + not rotated	X	
107	FCS block 18 replace + rotated + not rotated	X	
108	FCS block 19 replace + rotated + not rotated	X	
109	FCS block 20 replace + rotated + not rotated	X	
111	Table test	X	
117	Incoming SSU function	X	
118	Outgoing SSU function	X	
120	PLC command A + B	X	
121	PLC status A + B	X	
130	Valid path forwards in current segment [mm]	X	
131	Valid path backwards in current segment [mm]	X	
140	Set distance [mm]	X	
141	Actual distance (distance control) [mm]	X	
142	Actual distance [mm]	X	

Display mode	Meaning	dec.	hex.
143	Actual distance receiver (DKZ/TCU) [mm]	×	
144	Target position (last) [mm]	×	
145	Target position (reference) [mm]	×	
146	Destination index	×	
147	Open path sent to converter [mm]	×	
150	Active error number	×	
152	CAN bus error status (converter communication)	×	
153	Converter parameter error index	×	
160	Bus time-out ms	×	
170	Actual segment: Position point	×	
171	Current segment: prev1	×	
172	Current segment: prev2	×	
173	Current segment: prev3	×	
174	Current segment: next1	×	
175	Current segment: next2	×	
176	Current segment: next3	×	
177	Current segment: dest2	×	
178	Current segment: dest3	×	
179	Current segment: vel1	×	
180	Current segment: vel2	×	
181	Current segment: vel3	×	
182	Current segment: dist	×	
183	Current segment: control flags	×	
200-219	Debug area (relevant for the service team of Conductix-Wampfler Automation GmbH)	×	
235	BV - [Inverter CPU] BOOTLOADER	×	
236	BV - [Inverter CPU] BIOS / USER	×	
237	BV - [User CPU] BOOTLOADER	×	
238	BV - [User CPU] BIOS	×	
239	BV - [User CPU] USER	×	

Display mode	Meaning	dec.	hex.
250-253	Debug pages (relevant for the service team of Conductix-Wampfler Automation GmbH)	X	

Tab. 27: Display modes

Display mode 000	Target electrical frequency Shows electrical frequency with which the motor is powered.
Display mode 001	Actual electrical frequency Shows measured frequency with which the motor actually rotates. (Requires exact parameter assignment.)
Display mode 002	Set speed Shows speed specification to the converter.
Display mode 003	Actual speed Speed measured by the converter.
Display mode 004	CPU temperature Shows the current processor temperature of the converter.
Display mode 005	DC link voltage Shows the current voltage level in the intermediate circuit of the converter.
Display mode 006	Motor temperature Current temperature measurement value of the motor. With asynchronous motors, the resistance value is displayed; with micro-motors the temperature value.
Display mode 007	Motor power Displays the current power consumption of the motor.
Display mode 008	Control word Displays the status of the control word which is cyclically transmitted to the converter.

Control word

Displayed value	Position of the bit in binary number	Meaning
0001	Bit 1	Stop/start (0/1)
0002	Bit 2	Error reset
0004	Bit 3	Apply brake
0008	Bit 4	Release brake
0010	Bit 5	Operating mode Bit 0*
0020	Bit 6	Operating mode Bit 1*
0040	Bit 7	Bit 0 selection parameter set "motion"
0080	Bit 8	Bit 1 selection parameter set "motion"
0100	Bit 9	Bit 2 selection parameter set "motion"
0200	Bit 10	Bit 0 selection parameter set "motor"
0400	Bit 11	Bit 1 selection parameter set "motor"
0800	Bit 12	Close gaps
1000	Bit 13	Jerk limit
2000	Bit 14	Positioning for reverse movement
3000	Bit 13 and 14	Controlled operation
4000		
8000		Motor phase error detection

*

Operating mode bits (binary)	Meaning
00	Asynchronous
01	Synchronous
10	Synchronous + distance check
11	-

Tab. 28: Display mode 008

**Position of the operating mode bits:**

Example: Hexadecimal display; 0020

Binary number: 0000 0000 0 **10** 0 0000 (operating mode bits highlighted in bold and with additional distance)

→ Operating mode: synchronous + distance check

Display mode 009 Stopping distance from set speed

Displays the stopping distance of the vehicle based on the current set speed.

Display mode 010 Stopping distance from actual speed

Displays the stopping distance of the vehicle based on the current actual speed.

Display mode 011 Inverter status

Additional status information

Displays the status of the control word which is cyclically sent from the converter.

Displayed value	Position of the bit in binary number	Name	Meaning
0001	Bit 1	Enabling	Bit 1: Enabling set Bit 0: Enabling withdrawn
0002	Bit 2	Status	
0004	Bit 3	Status	
0008	Bit 4	Status	
0010	Bit 5	Brake	Bit 1: Brake applied Bit 0: Brake opened
0020	Bit 6	Move-ment	Bit 1: Motor rotates Bit 0: Motor stopped
0040	Bit 7	24 V	Bit 1: 24V level OK Bit 0: 24V level not OK
0080	Bit 8	-	not used
0100	Bit 9	Error0	Error in error group 0
0200	Bit 10	Error1	Error in error group 1
0400	Bit 11	Error2	Error in error group 2
0800	Bit 12	Speed	Bit 1: Set speed reached Bit 0: Set speed not reached
1000	Bit 13	Relay	Bit 1: Relay OK Bit 0: Relay not OK
2000	Bit 14	Mode	
4000	Bit 15	Mode	
8000	Bit 16	Stop	Bit 1: stopped due to distance check Bit 0: not stopped

002 / 004 / 008

Status bits	Meaning
000	Initialization
001	Idle
010	Offline
011	Online
100	Brief stop
101	Error response
110	Error
111	-

2000 / 4000

Mode bits	Meaning
00	Asynchronous
01	Synchronous
10	Synchronous + distance check
11	-

Tab. 29: Display mode 011

Example

Position of the status bits

Hexadecimal display - 0006

↵ Binary number - 0000 0000 0000 0110

↵ Status - Online

Example

Position of the mode bits

Hexadecimal display - 2000

↵ Binary number - 0010 0000 0000 0000

↵ Mode - Synchronous

Display mode 013

Error word 0

Displays which errors are active in the converter.

Each bit listed in the table stands for an error. If the flag is set, the related fault is active.

Displayed value	Meaning	
000001	Vcc supply voltage	[F003]
000002	Excess current	[F005]
000004		
000008	Short circuit	[F011]
000010	PE short circuit	[F004]
000020	Converter T1 storage	[F014]
000040	Brake voltage	[F110]
000080	Parameter value	[F016]
000100	Motor encoder1 offline	[F118]
000200	Motor encoder1 offline	[F119]
000400	24V supply voltage	[F010]
000800	Relay	[F012]
001000	Phase error	[F002]
002000	Overvoltage	[F111]
004000	Low voltage	[F112]
008000	Excess converter current	[F018]
010000	Excess temperature	[F019]
020000	Mains failure	[F001]
040000	Chopper overload	[F117]
080000	CAN bus offline	[F013]
100000	Phase plausibility check	[F115]
200000	Brake short circuit	[F110]
400000	heat sink temperature plausibility check	[F019]

Tab. 30: Display mode 013

**Display mode
014****Error word 1**

Displays which errors are active in the converter.

Each bit listed in the table stands for an error. If the flag is set, the related fault is active.

Displayed value	Meaning	
0001	Excess motor temperature	[F114]
0002	Excess motor current	[F115]
0004	Motor ID	[F11B]
0008	Motor phase error	[F11A]

Displayed value	Meaning	
0010	Motor error / control system ID	[F11B]
0020	Motor temperature plausibility check	[F114]
0040	Motor check	[F11C]
0080	Motor phase error V	[F11A]
0100	Motor phase error W	[F11A]

Tab. 31: Display mode 014

Display mode 015**Error word 2**

Displays which errors are active in the converter.

Each bit listed in the table stands for an error. If the flag is set, the related fault is active.

Displayed value	Meaning	
0001	Synchronous movement	[F116]
0002	Speed monitoring	[F113]

Tab. 32: Display mode 015

Display mode 018**Converter position**

The converter works internally with its own position value. This is always compared with the position value of the externally connected position encoder. In the event of a read error of the external encoder, the converter interpolates this position value further using the speed of the vehicle. The current position value from the position encoder is displayed.

Display mode 020**Current parameter sets Motor and Motion**

The converter has different parameter sets which can be switched to during motion. The display mode displays which parameter set is currently active.

- Ten's digit = Motor
- Unit's digit = Motion

Display mode 025**Movement enabling**

Every bit listed in this display value stands for a cause for bringing the vehicle to a standstill (sets the speed setpoint value to 0).

Displayed value	Position of the bit in binary number	Meaning
0001 ¹	Bit 1	Error
0002 ¹	Bit 2	Approach sensor 1
0004 ¹	Bit 3	Approach sensor 2
0008 ¹	Bit 4	Stop switch
0010 ¹	Bit 5	In Position
0020 ¹		Z-stop
0040 ¹		<i>SensoPart</i>
0080 ¹		Brake
0100 ¹		Burst ²
0200 ¹		Test mode
0400 ¹		No reference speed
0800 ¹		Distance
1000 ¹		Vacuum cleaner (output)
2000 ¹		Light sensor 1
4000 ¹		Light sensor 2
8000 ¹		PCM synchronisation delay

¹ The enabling is set when the bit is set. If it is deleted, the enabling is withdrawn.

² Converter parameters can be transmitted individually or as a block (several together). To save time, the parameters are transmitted to the converter in a large block after importing the MU data. This block is a burst.

Tab. 33: Display mode 025

Display mode 026

Internal commands

Internal control flags indicates which behaviour the control system should have through the present command.

Displayed value	Meaning
0001	Movement
0002	Backwards
0004	Positioning
0008	Synchronous
0010	Bleed brake
0020	Distance
0040	Manual mode

Displayed value	Meaning
0080	Close gaps
0100	Ascent
0200	Descent
0400	Special settings
0800	Message when the approach sensor is activated

Tab. 34: Display mode 026

Display mode 027

Hidden components

Value displays which external components have been deactivated by the configuration of the PCM command (PCM configuration table).

Displayed value	Meaning
0001	Approach sensor 1
0002	Approach sensor 2
0004	Magnetic switch 1
0008	Magnetic switch 2
0010	Magnetic switch 3
0020	Light sensor 1
0040	Light sensor 2

Tab. 35: Display mode 027

Display mode 028

Motor voltage

Displays the current voltage level with which the motor is controlled.

Display mode 029

Motor current

Displays the current electrical current consumption of the connected motor.

Display mode 030

Heat sink temperature

Shows the temperature of the heat sink.

Display mode 032

Error word parameter identification

Indicates whether an error has occurred during parameter identification.

Displayed value	Meaning
0	No error during parameter identification
1	Error during parameter identification

Tab. 36: Display mode 032

Display mode 035**Position encoder status**

This display mode shows the status of the externally connected position encoder. If this value is $\neq 0$, the current position value cannot be detected.

Display mode 036**Encoder position - unfiltered**

This display mode shows the currently read position value from the external position encoder.

Display mode 037**Encoder position - filtered**

This display mode shows the position value of the control system. This may originate from the external position encoder or from the interpolated position value of the converter.

Display mode 038**Current distance encoder value**

This value shows the current distance to the vehicle in front when using the distance sensor FR-85.

Display mode 039**Distance encoder distance index**

The value indicates the currently used index which is used for the distance maintenance with the distance sensor FR-85. The index is set in the PCM command configuration. (PCM configuration table)

Display mode 040**I/O card inputs**

Value indicates the status of the individual inputs of the I/O card. If a bit=1, the input is set.

Displayed value	Meaning	Socket
0001	Dependent on parameter [C113]	X13_4
0002	Dependent on parameter [C114]	X14_2
0004	Dependent on parameter [C114]	X14_4
0008	Dependent on parameter [C115]	X15_2
0010	Dependent on parameter [C115]	X15_4

Displayed value	Meaning	Socket
0020	Dependent on parameters [CI16] [CI13]	X16_2 / X13_2
0040	Dependent on parameter [CI16]	X16_4
0080	Dependent on parameter [CI17]	X17_4

Tab. 37: Display mode 040

**Display mode
041****I/O card outputs**

Value indicates the status of the individual outputs of the I/O card. If a bit=1, the output is set.

Displayed value	Meaning	Socket
0001	Dependent on parameter [CO17]	X17_2
0002	Dependent on parameter [CO17]	X17_5
0004	Activating the inputs	-
0008	LED1 (on internal I/O card)	-
0010	LED2 (on internal I/O card)	-
0020	LED3 (on internal I/O card)	-

Tab. 38: Display mode 041

**Display mode
050****PCM command**

The value indicates the PCM command currently present on command rail 1.

Set	PCM	Configuration	Speed	Distance
1	1	0x0000	-	-
2	2	0x0001	0 (V0)	0 (Dist 0)
3	3	0x0002	0 (V0)	0 (dist. 0)
4	4	0x0001	1 (V1)	0 (dist. 0)
5	5	0x0002	1 (V1)	0 (dist. 0)
6	6	0x0001	2 (V2)	0 (dist. 0)
7	7	0x0002	2 (V2)	0 (dist. 0)
8	8	0x0001	3 (V3)	0 (dist. 0)
9	9	0x0002	3 (V3)	0 (dist. 0)
10	10	0x0001	4 (V4)	0 (dist. 0)
11	11	0x0002	4 (V4)	0 (dist. 0)

Set	PCM	Configuration	Speed	Distance
12	12	0x0001	0 (V0)	1 (dist. 1)
13	13	0x0002	0 (V0)	1 (dist. 1)
14	14	0x0001	1 (V1)	1 (dist. 1)
15	15	0x0002	1 (V1)	1 (dist. 1)
16	16	0x0001	2 (V2)	1 (dist. 1)
17	17	0x0002	2 (V2)	1 (dist. 1)
18	18	0x0001	3 (V3)	1 (dist. 1)
19	19	0x0002	3 (V3)	1 (dist. 1)
20	20	0x0001	4 (V4)	1 (dist. 1)
21	21	0x0002	4 (V4)	1 (dist. 1)
22	22	0x0001	0 (V0)	2 (dist. 2)
23	23	0x0002	0 (V0)	2 (dist. 2)
24	24	0x0001	1 (V1)	2 (dist. 2)
...	
47	47	0x0002	2 (V2)	4 (dist. 4)
48	48	0x0001	2 (V3)	4 (dist. 4)
49	49	0x0002	3 (V3)	4 (dist. 4)
50	50	0x0001	4 (V4)	4 (dist. 4)
51	51	0x0002	4 (V4)	4 (dist. 4)
52	52	0x0008	-	0 (dist. 0)
53	53	0x0000	-	0 (dist. 0)
54	54	0x0011	9 (V9)	0 (dist. 0)
55	55	0x0012	9 (V9)	0 (dist. 0)
56	56	0x0021	10 (V10)	0 (dist. 0)
57	57	0x0022	10 (V10)	0 (dist. 0)
58	58	0x0005	V12+V13*(PCM-58)	0 (dist. 0)
59	59	0x0005	V12+V13*(PCM-58)	0 (dist. 0)
60	60..191	0x0005	V12+V13*(PCM-58)	0 (dist. 0)

PCM commands can be configured with the table "PCMconfig". The table illustration shows the delivery condition of the PCM commands. An individual speed index, distance index and behaviour index can be set for PCM commands 1-60.

The size of PCMconfig is (60 x (2 + 1 + 1) bytes)

PCM	
200	Positive half wave
201	Negative half wave
202	Full wave

Display mode 051

IR command

The value indicates the current infra-red command of the remote control.

IR command	Function
2	Forwards slowly
3	Backwards slowly
4	Forwards quickly
5	Backwards quickly
29	Bleed brake

Display mode 053

Z-stop

The value indicates the command currently present on command rail 2. This is used for Z-stop. If the value 202 is displayed, a full wave is present. This way the vehicle is stopped.

Display mode 054

GET (old method)

This display mode shows the GET value (speed of the vehicle at a motor frequency of 50 Hz). This value was used in control systems of older series.

Display mode 055

Relay status notification

Value shows the switch condition of the signal relay.

Displayed value	Meaning
0001	Relay for positive half wave activated
0002	Relay for negative half wave activated

Tab. 39: Display mode 055

Display mode 057

Number of motor pole pairs

Value indicates the quantity of used pole pairs of the motor. It is set through the parameter *[rate motor speed]* (*[Rot_]*).

STB_0004, 10, en_GB

Display mode 060 **Internal command**
Value indicates the internal command for the motion axis.

Display mode 080 **Vehicle number**
Value indicates the current vehicle number.

Display mode 081 **Vehicle type**
Value indicates the current vehicle type.

Display mode 090-109 **FCS block**

090	FCS block 1 rotated + not rotated
091	FCS block 2 rotated + not rotated
092	FCS block 3 rotated + not rotated
093	FCS block 4 rotated + not rotated
094	FCS block 5 rotated + not rotated
095	FCS block 6 rotated + not rotated
096	FCS block 7 rotated + not rotated
097	FCS block 8 rotated + not rotated
098	FCS block 9 rotated + not rotated
099	FCS block 10 rotated + not rotated
100	FCS block 11 rotated + not rotated
101	FCS block 12 rotated + not rotated
102	FCS block 13 rotated + not rotated
103	FCS block 14 rotated + not rotated
104	FCS block 15 rotated + not rotated
105	FCS block 16 rotated + not rotated
106	FCS block 17 rotated + not rotated
107	FCS block 18 rotated + not rotated
108	FCS block 19 rotated + not rotated
109	FCS block 20 rotated + not rotated

Tab. 40: Display mode 090-109

The FCS of the used tables are displayed here.

For swapped and unswapped byte sequences.

Display mode 111 **Table test**

If a table error [FD08] occurs, the table shows values that have not been correctly loaded or written.

For correct functioning of the control system, all table data must be stored in the control system. If table data is not specified in the control system or is invalid (internal FCS check), this error is output. The table data is on the internal memory of the control system. If the table data is not available, it must be imported. Otherwise the service team of Conductix-Wampfler Automation GmbH must be contacted.

Message	Table index	Table
00001	0	Parameter exchange 1
00002	1	Parameter exchange 2
00004	2	PCM table
00008	3	Asynchronous speed table
00010	4	Distance table (PCM)
00020	5	Distance table (rail bus)
00040	6	Target table
00080	7	Synchronous speed table
00100	8	Stop offset
00200	9	-
00400	10	-
00800	11	-
01000	12	Segment table 1
02000	13	Segment table 2
04000	14	Segment table 3
08000	15	Segment table 4
10000	16	Segment table 5
20000	17	Segment table 6
40000	18	Segment table 7
80000	19	Segment table 8

Tab. 41: Display mode 111

**Display mode
117**

Incoming SSU function

Value shows the function index of the last incoming acyclic read access.

**Display mode
118**

Outgoing SSU function

Value shows the function index of the last outgoing acyclic read access.

**Display mode
120****PLC command A+B**

Display of the command bytes A and B of the incoming cyclical command byte.

**Display mode
121****PLC status A+B**

Display of the status messages which are sent cyclically from the vehicle.

**Display mode
130-131****Valid path**

130	Valid path forwards in current segment
131	Valid path backwards in current segment

Display of the valid area boundaries for the current segment.

**Display mode
140****Distance reference**

The value corresponds to the set distance which is used for maintaining distance.

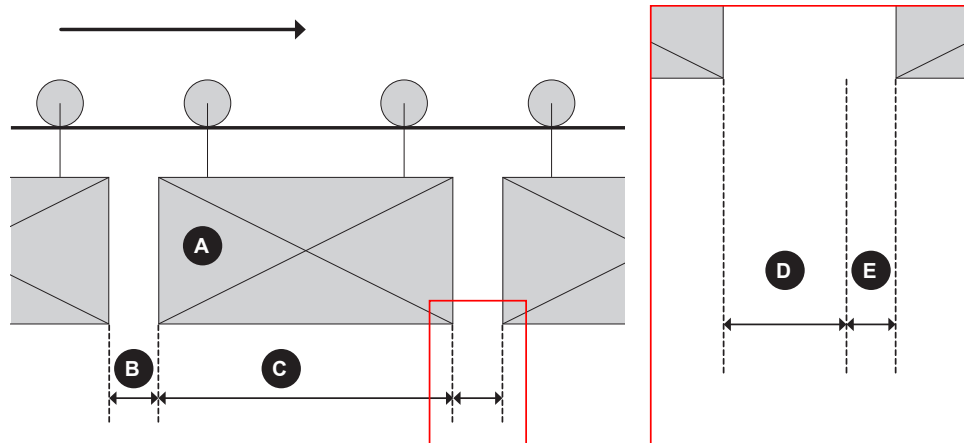

Fig. 25: Distances

- A Vehicle
- B Vehicle distance - Target distance + Stop distance
- C Vehicle length - Parameter
- D Target distance as per distance table
- E Stop distance - Parameter

**Display mode
141****Actual distance (distance control)**

This value indicates the actual distance for the distance control.

Display mode 142 **Actual distance (safe stop)**
 This value indicates the actual distance for the distance maintenance.

Display mode 143 **Open path (DKZ / TCU)**
 Distance to the vehicle in front.
 This value is calculated from DKZ / TCU.

Display mode 144 **Target position (last)**
 Shows the current position at which the vehicle is stopped.

Display mode 145 **Target position (reference)**
 Indicates the target position transferred as position value.

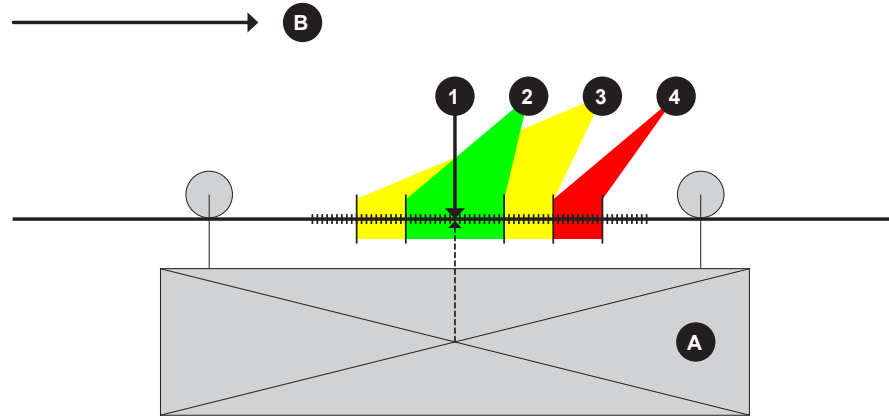

Fig. 26: Target position

- A Vehicle
- B Movement direction
- 1 Stop position
- 2 Positioning window
- 3 Monitoring
- 4 Tolerance

Display mode 146 **Destination index**
 Current target index To determine the target position, the target table is accessed in this index and the target position value is read.

Display mode 147 **Open path sent to converter**
 The **open path** which is sent to the converter. If the value goes to zero, the vehicle stops independently.
 Is used for positioning and distance maintenance.

STB_0004, 10, en_GB

Display mode 150 **Active error number**
Number of currently active errors.

Display mode 152 **Error status - CAN bus (converter communication)**
Cause of error when transmitting parameters to the converter.

Message	Cause
0	Data transmission is running
1	Last package successfully transmitted
2	Incorrect parameter index
3	Too many parameters
4	Time exceeded
5	Incorrect start index
6	Checksum error
7	Incorrect parameter value
8	Unknown error

Tab. 42: Display mode 152

Display mode 153 **Error index - Converter parameters**
Index of the incorrect parameter which was sent to the converter.

Display mode 160 **Bus time-out**
Current time (ms) between 2 cyclical rail bus telegrams.

Display mode 170-183 **Entries of the segment table for the current system segment**
Entries of the segment table for the current system segment in which the vehicle is located.

170	Current segment:	Position point
171		prev1
172		prev2
173		prev3
174		next1
175		next2
176		next3

177	dest2
178	dest3
179	vel1
180	vel2
181	vel3
182	dist
183	control flags

Display mode 200-219

Debug area

Conductix-Wampfler service

Display mode 235-239

BV

235	BV - [Inverter CPU] BOOTLOADER
236	BV - [Inverter CPU] BIOS / USER
237	BV - [User CPU] BOOTLOADER
238	BV - [User CPU] BIOS
239	BV - [User CPU] USER

List of software version numbers which are in the control system.

Display mode 250-253

Debug pages

Conductix-Wampfler service

9.3.3.1 Creating/modifying display modes

Display modes are selected in the MU-705 manual programming device.



Reference

For information about the manual programming device, please refer to the corresponding operating manual:

- *BDA_0005_MU-705.pdf*

The operating manual is part of the project documentation or can be downloaded from www.conductix.com.

A maximum of four display modes can be displayed simultaneously.

The first display mode entered is displayed in the fourth line of the display. The last display mode entered is displayed in the first line of the display.

If more than four numbers are entered, the number first entered is deleted again.

1. ▶ Switch on the manual programming device.
2. ▶ Open the following menu items in the manual programming device: 'Target/number → Display'
3. ▶ Enter the number of the display mode which is to be displayed in the last line.
4. ▶ Transfer change to the vehicle control system.



Distance between the manual programming device and the control system

Data is transferred via infra-red. For successful data transmission, the distance to the display of the control system and the IR receiver may be max. 1 m at an angle of 16°.

5. ▶ Repeat the process for all display modes that are to be displayed.

9.3.3.2 Calculating and evaluating hexadecimal values

Some values are displayed in the form of a four-digit hexadecimal number on the display. To evaluate what the displayed number means, the number must be converted into binary format.

Hexadecimal	0	1	2	3	4	5	6	7
Binary	0000	0001	0010	0011	0100	0101	0110	0111
Hexadecimal	8	9	A	B	C	D	E	F
Binary	1000	1001	1010	1011	1100	1101	1110	1111

Example

Hexadecimal number: 8E01

	8	E	0	1
	1 0 0 0	1 1 1 0	0 0 0 0	0 0 0 1
Bit	16	12 11 10		1

Meaning in display mode 011 "Inverter status"

Bit 1	Enabling set
Bit 10	Error in error group 1
Bit 11	Error in error group 2
Bit 12	Set speed reached
Bit 16	Stopped due to distance check



Meaning of set bits

The meaning of set or non-set bits can be found in the legend of the respective display mode.

9.4 Vehicle remote control

In automatic mode, the control system receives the relevant commands for moving the vehicle from the higher-level system controller or runs an internal driving program.

In manual or unrestrained manual mode, the vehicle can be moved manually using optional hand-held remote controls (FB) or a manual programming device (MU).



Reference

Information on the hand-held remote controls can be found in the corresponding operating manual:

- *BDA_0002_FB-606.pdf*
- *BDA_0003_FB-706.pdf*
- *BDA_0018_FB-8.pdf*

The operating manuals are part of the project documentation or can be downloaded from www.conductix.com.



Reference

For information about the manual programming device, please refer to the corresponding operating manual:

- *BDA_0005_MU-705.pdf*

The operating manual is part of the project documentation or can be downloaded from www.conductix.com.

9.4.1 Changing operating mode



⚠ WARNING!

Automatic start-up

Risk of fatality due to moving machine parts!

If the control system is in automatic mode or is going to be switched to automatic mode, an automatic start-up of the system is to be expected at any time.

- No persons in the danger zone of moving system parts!
- Only activate the control system under supervision!

Activating manual mode

- ➔ Press the button  on the remote control in automatic mode.
 - ⇒ The vehicle control system is in manual mode. The blue LED is flashing.

Activating automatic mode

- ➔ Press the button  on remote control in manual mode.
 - ⇒ The vehicle control system is in automatic mode.

Activating unrestrained manual mode

- ➔ Activate *[SW12]* configuration switch in the manual programming device and transfer the new configuration to the vehicle control system.

9.4.2 Moving the vehicle manually



⚠ WARNING!

Danger of crushing











When moving vehicles in **manual mode** or **unrestrained manual mode**, safety equipment or safety functions may be deactivated.

Death or serious injuries could result.

- The moving of vehicles in **manual mode** or **unrestrained manual mode** must only be performed by instructed personnel.
- When moving vehicles in **manual mode** or **unrestrained manual mode**, there should be no people in the action area of the vehicle.
- Operate the vehicle remotely only when it is in the line of sight.

Movement with remote control

In manual mode and unrestrained manual mode, the vehicle can be controlled using the remote control by means of the following buttons.

Key	Function
	Switchover to manual mode
	Switchover to automatic mode
 + 	Release brake
	Slow forwards movement
 + 	Fast forwards movement
	Slow forwards movement
 + 	Fast backwards movement

**Vehicle/control system stop**









The movement is performed for as long as the button – or buttons, in the case of fast movements – are released. In this process the movement is not stopped abruptly. Instead it is cushioned by the control system.

**Distance between the the remote control and the control system**

The commands are transmitted via infra-red. The range of the remote control is at least 6 m with a transmission/reception angle of $\pm 24^\circ$ to the display of the control system or the IR receiver.

Moving with the manual programming device

In manual mode and unrestrained manual mode, the vehicle can be controlled using the remote control by means of the following buttons.

Key	Function
	Switchover to manual mode
	Switch between slow manual mode and fast manual mode
	Switchover to automatic mode
 or 	Forwards movement (slow or fast)
 or 	Backwards movement (slow or fast)
 + 	Release brake



Distance between the manual programming device and the control system

Data is transferred via infra-red. For successful data transmission, the distance to the display of the control system and the IR receiver may be max. 1 m at an angle of 16°.

10 Faults



Note

Any detected malfunction automatically leads to an immediate stop of the vehicle!

10.1 Displaying faults and errors

Fault indicator

If the vehicle is in error mode, the error number and a red LED flash. Error number and error message are shown in alternation.

If more than one error is active, the various numbers and messages are displayed one after the other.

The error number is composed of a large "F" and a three-digit hexadecimal number.

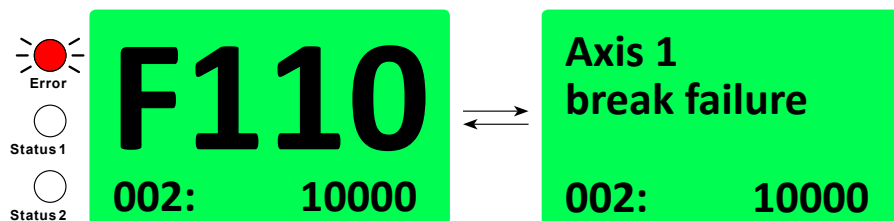

Fig. 27: Display – Error message



Fault indicator can be deactivated through configuration switch [SW13].

10.2 Error messages



Error message – PCM communication

Errors are transmitted via the signal rail to the system controller as collective faults.



Error message – Bus communication

Errors that occur on the control system are forwarded on to the higher-level system controller and can also be displayed there, depending on the system controller.



Reference

Error messages are described in a separate document:

- [STB_0011_ST-87x-Error_messages.pdf](#)

10.3 Error codes

Error codes are displayed with an 'F' and 3 digits.

	1st digit	2nd digit	3rd digit
Converter fault			
F	0	0 ^E ; 1 ^F , 2 ^F , 3 ^F , 4 ^F , 5 ^F , 6 ^F , 7 ^F , 8 ^F , 9 ^F	0...9 / A...F
Axis-related fault			
F	1 ^{A,D} / 2 ^{B,D} / 3 ^D / 4 ^D / 5 ^D / 6 ^D / 7 ^D	1...7	0...9 / A...F
Safety circuit fault			
F	8	0...9 / A...F	0...9 / A...F
Application error			
F	A	0...9 / A...F	0...9 / A...F
I/O system error			
F	B	0...9	0...9 / A...F
Communication error			
F	C	0...9 / A...F	0...9 / A...F
Data error			

F	D	0, 1	0...9 / A...F
External device fault^c			
F	E	0...9 / A...F	0...9 / A...F

^A Axis 1 is always the motion axis (except vehicles without motion drive)

^B Axis 2 is always the stroke axis (only relevant for control systems from ST-89x)

^C Error code (only for control systems ST-88x, ST-89x as well as special control systems)

^D Motion axis number

^E Infeed/supply

^F Frequency converter number

Tab. 43: Error codes

10.4 Fault types

- **Faults to be acknowledged manually**
- **Self-acknowledging faults**

Faults to be acknowledged

Faults whose cause or effect could lead to personal injury, damage to the system or plant stoppages must be acknowledged.

All faults to be acknowledged manually are saved in the error log.

A **Resetting** of the error message can only be **performed** manually:

- **Manual reset**
- **Power on reset**

Self-acknowledging faults

Faults whose cause or effect do not lead to personal injury or damage to the system acknowledge themselves provided the cause of the fault is no longer present.

Self-acknowledging faults are saved in the error log.

The error message is reset automatically – **Self-reset**.



⚠ WARNING!

Automatic start-up

Danger posed by unintended activation of the control system and start-up of motors and drive units.

Risk of crushing limbs, catching and dragging of loose items of clothing due to moving machine parts

- No persons in the danger zone of moving system parts
- Deactivate automatic start-up
- Only activate control system under supervision
- If necessary, disengage the drive.
- If necessary, disconnect the vehicle from voltage.
- Keep clear of moving system parts.
- Do not reach into the running machine.
- Wear tight-fitting work clothes.
- Pay attention to optical and acoustic warning equipment.



NOTICE!

Monitoring the error log

Damage to the control system

Causes of self-acknowledging faults may re-appear.

- To prevent permanent damage, the error logs must be checked for abnormalities.

10.5 Fault reset

After eliminating the cause of the fault, a present fault can be reset.



Resetting faults:

- Manual Reset (MR)
- Power on Reset (POR)
- Self-Reset (SR)



Manual Reset (MR)

- Change operating mode
- Confirm operating mode
- Press start/stop switch

Change operating mode

1. ➤ Switching from automatic to manual mode
 Press remote control button 
 ⇒ Fault acknowledged
2. ➤ Switching back from manual to automatic mode
 Press remote control button 

Confirm operating mode

- Pressing the buttons for the current operating mode
 Press remote control button  or 
 ⇒ Fault acknowledged

Press start/stop switch

- Pressing the start/stop switch
 Press the start/stop switch on the control system
 ⇒ Fault is acknowledged after releasing the switch

Power on Reset (POR)

1. ➤ Switch off busbar or disconnect the control system from the busbar
 ⇒ Fault acknowledged
2. ➤ Switch on busbar / re-connect the control system to the busbar



*The option **Power on Reset** Only use if the fault was not reset by pressing the start/stop switch.*

Self-Reset (SR)

Self-acknowledging fault ↪ *'Self-acknowledging faults' on page 149*
 Faults that reset themselves once the cause of the fault has been eliminated.

11 Service and maintenance

11.1 Maintenance and cleaning

Operation and maintenance

The operation and maintenance of the control system must only be performed by trained and qualified personnel. Staff undergoing instruction and training are allowed to perform activities on and with the control system under the constant supervision of a trained and qualified individual.



⚠ WARNING!

Danger to life from electrical current!

Contact with live parts poses an immediate danger to life.

- Disconnect the system from the power supply and secure it against being switched on again before servicing and cleaning the control system.



Opening the control system for testing purposes is not intended.

11.1.1 Maintenance



NOTICE!

Mechanical loads may lead to device failure.

- Check the device for damage at regular intervals.
- Opening the device for testing purposes is not intended.

Service the device as follows:

- **Brackets**
 - Check for loose connections.
- **Connections**
 - Check for loose connections.
 - Check cable insulation.
 - Cover any ports not being used.
- **Indicators**
 - Remove soiling.
- **Recommended maintenance interval**
 - 6 months

11.1.2 Cleaning



NOTICE!

Damage to the device due to improper cleaning

- Do not use any cleaning agents, such as methylated spirits, or other cleaners!
- Do not clean with sharp objects!

Clean the device as follows:

- **Device**
 - Clean with dry cloths only.
- **Recommended cleaning intervals**
 - 6 months

11.2 Removing / replacing the control system



⚠ WARNING!

Changing the control system

Danger posed by faulty installation.

Faults during installation may lead to potentially fatal situations or considerable material damage.

- Have installation performed exclusively by employees of the manufacturer or by trained personnel authorised by it.
- Works on electric components may only be carried out by qualified electricians or persons instructed and supervised by a qualified electrician in accordance with the electro-technical regulations.
- Only disconnect plug connections to external componentry when in a de-energised state.
- Before carrying out work on the control system, make sure it is de-energised and secured against accidental reactivation.
- Prior to commissioning, ensure that all safety equipment is installed and functioning properly.
- Prior to commissioning, ensure that parameter assignment on the device has been performed correctly in accordance with the electrical and mechanical conditions of the system.



⚠ WARNING!

Start/stop switch

The start/stop switch does not disconnect the controller from the power supply. Dangerous voltage is present.

- The control system must be disconnected from the power supply when performing work on it.

11.2.1 Control system removal



Reading parameters and tables

If possible, read and save the current parameters and tables from the control system using the MU-705 manual programming device.

How to remove the control system:

1. ➤ Switch off the control system with the start/stop switch.
2. ➤ Switch off the power supply and protect against accidental reactivation.



⚠ WARNING!

Electric shock due to capacitors not having fully discharged

Some components of the vehicle controllers, especially the intermediate circuit of the frequency inverters, may still retain voltage after switching off. Work on these components may only be carried out after the intermediate circuit has discharged!

Risk of fatality posed by electric shock!

Disconnect the power supply safely:

- Disconnect system from power
- Disconnect collector from busbar

Waiting time after voltage isolation: At least 10 minutes

3. ➤ Disconnect external connections.
4. ➤ If available: Remove the DataCom stick.
5. ➤ Disconnect mechanical connections.

11.2.2 Control system installation

How to install the control system:

1. ► Check the new control system for transport damage.
2. ► Install the control system mechanically.
3. ► Connect voltage-free external connections with the control system.
4. ► If available, connect the DataCom stick.
5. ► Put the control system into service. ↪ *Chapter 'Commissioning' on page 67*



Reading parameters and tables

Transfer saved parameters and tables of the 'old' control system to the control system using the MU-705 manual programming device.

(Configure vehicle number and type, if necessary.)

11.3 Repairing the control system

If a repair of the control system becomes necessary, please refer to your next service partner or go directly to Conductix-Wampfler Automation GmbH.

↪ *Chapter 'Customer service and addresses' on page 183*



Repairs

The repair of a defective control system must only be performed by the staff of Conductix-Wampfler or specialists trained by Conductix-Wampfler.

In the event of repairs by unauthorised persons, all warranty claims against Conductix-Wampfler Automation GmbH are invalidated.

12 Disposal

12.1 Information on disposal and environmental regulations

If no return or disposal agreements exist, the individual components are to be properly dismantled and then separated and disposed of pursuant to current regulations or taken for recycling.

The device comprises electric and electronic components. Separate and dispose of them according to applicable provisions.

Follow the hazardous materials directive, in particular the regulations on handling hazardous materials.

 Materials designated for recycling are to be disposed of as per the respective recycling procedure.

13 Technical specifications

13.1 Device

Dimensions

Type	Dimensions: W × H × D (mm)	
ST-870 / 880	200 × 200 × 90	
ST-871 / 881	200 × 200 × 90	
ST-872 / 882	200 × 200 × 119	
ST-873 / 883	200 × 200 × 131	Including mounting bracket

Tab. 44: ST-87x / 88x - Dimensions

Material

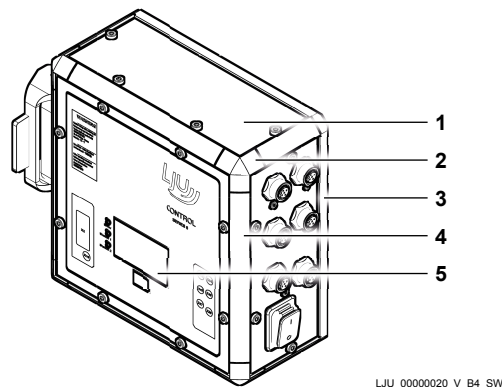

Fig. 28

- 1 Front and side plates
- 2 Profile corner
- 3 Mounting plate
- 4 Edge profile
- 5 Front film

Type	Material
Fig. 28/1	Aluminium
Fig. 28/2	Plastic ABS, green
Fig. 28/3	Aluminium
Fig. 28/4	Aluminium
Fig. 28/5	Polyethylene

Tab. 45: ST-87x / 88x material

Weight

Type	Weight (g)	
ST-870 / 880	approx. 3200	
ST-871 / 881	approx. 3200	
ST-872 / 882	approx. 4200	
ST-873 / 883	approx. 5100	Including mounting bracket

Tab. 46: ST-87x / 88x weight

Environmental conditions

Environmental conditions		
Climatic ambient conditions As per DIN IEC 60721-3-3	Category: 3K3 (Fixed-location usage*; weatherproof)	
Mechanical environmental conditions As per DIN IEC 60721-3-3	Category: 3M4 (Fixed-location usage*; weatherproof)	
Vibrations As per IEC 60068-2-6	10–58 Hz ± 0.075 mm	58–150 Hz 9.81 m/s ²
Shock As per IEC 60068-2-27	150 m/s ²	
Free fall In transport packaging	≤ 1.0 m	
Ambient temperature Without derating Non-condensing, no dew-formation	+10–+45 °C The control system is thermally inherently safe. If the heat sink is too high, shutdown occurs with an error message	
Ambient temperature With derating	+45–+60 °C 5 %/K at ST-870 / 871 / 880 / 881 4 %/K at ST-872 / 882 3 %/K at ST-873 / 883	
Maximum installation height Without derating	1,000 m above mean sea level	
Relative humidity	< 80% non-condensing	
Storage temperature	-10–+50 °C	
Protection class	1	
Protection class	IP54 Except port X1	
EMC conformity (Interference suppression)	EN 61800-3-compliant Category C2	

Environmental conditions

* The term **fixed location of usage** refers to use in conjunction with a rail system. The rail system must be designed so that the control system is not subjected to impermissible impacts.

Tab. 47: ST-87x / 88x ambient conditions

13.2 Input data

Power supply

Supply type	3-phase AC port, TT or TN mains with directly earthed star point
Rated input voltage	3 x AC 380 to 480 V (± 10 %)
Rated input frequency	50/60 Hz (± 5 %)

Tab. 48: ST-87x / 88x power supply

	ST-870 ST-880	ST-871 ST-881	ST-872 ST-882	ST-873 ST-883
Rated input current	3.5 A	6.0 A	8.0 A	10.0 A
Short-circuit current (SCCR)	5 kA			
Activation current	≤ 7 A 3 mains periods			
Power consumption Standby	8 W (without external consumers)			
Power loss (typical) Self-heating in still air by 35 K	31 W	31 W	43 W	48 W

Tab. 49: ST-87x / 88x power supply

Half-wave/PCM input

Input voltage range* Depending on hardware configuration	AC 220–277 V ± 10% AC 380–480 V ± 10%
Current consumption typical	3 mA
Input frequency synchronous to the grid	50 / 60 Hz (± 5%)

*Measured against the reference phase of the inputs.

Tab. 50: ST-87x / 88x - Half-wave/PCM input

STB_0004, 10, en_GB

Half-wave/Z-stop

Input voltage range* Depending on hardware configuration	AC 380–480 V \pm 10%
Current consumption typical	3 mA
Input frequency synchronous to the grid	50 / 60 Hz (\pm 5%)
*Measured against the reference phase of the inputs.	

Tab. 51: ST-87x / 88x - Half-wave/Z-stop

Digital inputs

Current consumption at 24 V	4.2 mA \pm 10%
High level	DC +18 ... +30 V
Low level	DC 0 ... +9 V

Tab. 52: ST-87x / 88x digital inputs

Quadrature inputs

	5 V configured	24 V configured	
	QA / QB	QA / QB	QC
Current consumption	1.0 mA (\pm 10%)	1.4 mA (\pm 10%)	4.2 mA (\pm 10%)
High level	DC +2.3 ... +5.0 V	DC +18 ... +30 V	
Low level	DC 0 ... +0.8 V	DC 0 ... +9 V	

Tab. 53: ST-87x / 88x quadrature inputs

13.3 Output data**General**

	ST-870	ST-871	ST-872	ST-873
	ST-880	ST-881	ST-882	ST-883
Braking and on resistance	100 Ω	100 Ω	100 Ω	100 Ω
	60 W	60 W	200 W	300 W
	Internal	Internal	External	External

Axis data

	ST-870	ST-871	ST-872	ST-873
	ST-880	ST-881	ST-882	ST-883
Rated motor power	0.75 kW	1.5 kW	2.2 kW	3.0 kW
Rated output current	2.5 A	4.2 A	6.0 A	8.0 A

	ST-870 ST-880	ST-871 ST-881	ST-872 ST-882	ST-873 ST-883
Maximum device currents (5s)	5.0 A	8.4 A	12.0 A	12.8 A
Operating mode As per IEC 60034-1	S3 60 % ED	S3 40 % ED		
Output voltage	3 X AC 0V ... U _{Network}			
Output frequency	3 ... 120 Hz			
PMW frequency	16 / 8 kHz (automatic / manually selectable)			
Motor protection	PTC / bi-metal (optional KTY)			
Maximum brake stop current	DC 0.3 A			
Brake control output voltage	DC 0.45 * U _{Network}			

Signal output

Relay contact	Max. permitted voltage 277 V Max. permitted load current 25 mA at 85°C (limited by PTC)
Integrated short-circuit protection	Yes
Max. ohmic load	100 kΩ
Max. capacitive load	69 nF

Digital outputs

Version	Short-circuit-proof
Rated output current Maximum	DC 500 mA per digital output
Inductive loads	Yes
High level	DC 24 V (± 5%) RON = 200 mΩ
Low level	< DC 1 V

NOTICE!



Excessive total current of external consumers

The total current of all external 24 V consumers at the digital outputs and the RS485 interface must not exceed 1.0 A.

13.4 Interfaces

RS485	Power supply	DC 24 V ($\pm 5\%$)
	Supply current Maximum	DC 500 mA
	Initial signal level	± 5 V differential
	Input signal level (min.)	± 200 mV differential
	Bus termination	Yes



NOTICE!

Excessive total current of external consumers

The total current of all external 24 V consumers at the digital outputs and the RS485 interface must not exceed 1.0 A.

SPI encoder (optional)

Hardware configuration	5 V supply	24 V supply
Power supply	DC 5 V $\pm 5\%$	DC 24 V $\pm 5\%$
Supply current Maximum	DC 50 mA	DC 50 mA
Interface configuration	5 V unipolar	RS485
Initial signal level	5 V logic	± 5 V differential
Input signal level	Low: 0–1.6 V High: 3.3–5.0 V	Min. ± 200 mV differential
Input current	1.4 mA	RS485 with bus connection

Rail bus

Voltage	AC 24 V modulated
Input signal	Differential
Current consumption	± 5 mA (tolerance: ± 1 mA)

Infra-red

Incidence angle	48°
Control system transmission range	1 m

13.5 Cable lengths and specifications

Connection between:		Cable length	Specification
Vehicle control system	Overhead monorail rails, L1, L2, L3, PE	≤ 2 m	≥ 2.5 mm ² A (AWG 14)

Overhead monorail rail, S1, S2, M		
Overhead monorail rail, Bus A, Bus B		
Brake resistor	≤ 1 m	≥ 1.5 mm ² (AWG 16)
Sensors	≤ 5 m	≥ 0.35 mm ² (AWG 22)
RS-485	≤ 5 m	≥ 0.35 mm ² ^B (AWG 22)
Motor	≤ 3 m	↪ Chapter 'EMC installation notes' on page 48

^A recommended, ^B shielded

13.6 Approvals and standards

Conformity

Devices made by Conductix-Wampfler Automation GmbH have been designed to comply with EU directives. Please contact Conductix-Wampfler Automation GmbH if you wish to obtain a copy of the EU Declaration of Conformity.

Certifications

Controllers of the types ST-87x / ST-88x are tested and certified as follows:

Tested according to	EN 61800-5-1:2007/A1:2017
Certificate number	B 063502 0029
Certification body	TÜV Süd Product Service GmbH
Certification mark	

Tested according to	UL 61800-5-1:2012/R:2021-02 CSA C22.2 No. 274:2017
Certificate number	U10 063502 0028
Certification body	TÜV Süd America Inc.
Certification mark	

STB_0004, 10, en_GB

14 Information and parameter assignment

To better understand the configuration options and effects of parameter and table values, different types of motors and the functioning of frequency converters are briefly explained in this section.

14.1 Three-phase current asynchronous motor

The three-phase asynchronous motor (TPASM) is one of the most important and common electrical drives.

14.1.1 Layout and function

The three-phase current asynchronous motor consists of a fixed stator and the rotation-mounted rotor. Stator and rotor are composed of thin, highly magnetisable electrical steel plates.

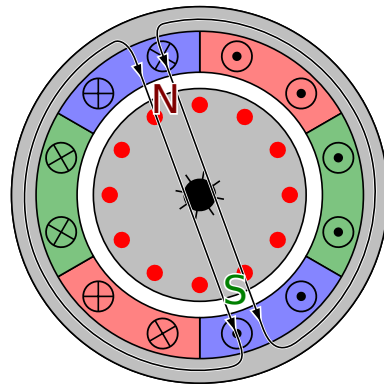

Fig. 29: Asynchronous motor with the pole pair number $p = 1$ and 3 phases Source: Wikipedia

Stator

The stator is not the moving part of the motor. It consists of plate packages in which there are coils made from copper wire in staggered arrangement. Each of these coils produces two magnetic poles. If three windings arranged with 120° staggering are integrated into the sheet packages, then this equates to the smallest pole pair number $p = 1$. Accordingly, the number of poles is deduced by $2 \times p$. If you add three more windings, also staggered in 120° arrangement, to a stator, the number of poles doubles.

If the rated frequency and the pole pair number of the motor are known, then the synchronous speed can be calculated (n_0):

$$n_0 = (f \times 60) / p$$

f = Frequency [Hz]

n_0 = Synchronous speed [rpm]

p = Pole pair number

Pole pair (p)	1	2	3	4	6
No. of poles (2X p)	2	4	6	8	12
n_0 [rpm] (50 Hz rated frequency)	3000	1500	1000	750	500
n_0 [rpm] (60 Hz rated frequency)	3600	1800	1200	900	600

Rotor

The rotor is the rotating part of the motor which is attached to the motor shaft. Like the stator, it is composed of grooved, cylindrical steel plate packages with aluminium bars. Since these bars sit like a cage in the rotor package and are connected to form a closed cage at the front by a ring, this is referred to as a 'squirrel-cage rotor' or 'cage rotor'. This is the rotor type used most commonly.

14.1.2 How it works

Motors use the induction principle in reversed order. A force acts on a current-conducting wire in a magnetic field which produces motion.

If the three windings of a three-phase asynchronous motor in a star or delta circuit are connected to a symmetrical three-phase mains supply, three 120°-phase-shifted currents of equal frequency and amplitude flow into the windings of the stator. They form a rotating magnetic field. This magnetic field acts on the rotor and induces a voltage in the wires that effects a current flow due to the short-circuit of the wires. This current generates a magnetic field, which rotates with the mains frequency f or f/p (p = pole pair number). The magnetic field of the stator acts on this magnetic field so that a rotary motion arises.

Idle operation

In idle, the motor current (no-load current) is used solely to magnetise the sheet metal body. The no-load current is approx. 40–50% of the rated motor current. The rotating field generated follows the rotor at almost synchronous speed.

Operating with loads

The rated load reduces the speed of the rotor to the on-load speed. This difference in speed is referred to as 'slip'. When slip increases, the rotor current, and thus the torque, also increase. Since the three-phase current asynchronous motor operates like a transformer, the rotor current on the stator side (secondary side) is transformed. Thus the current taken from the mains and the frequency converter also changes with increasing torque.

Generator operation

In generator operation, the motion energy is transferred to the motor from outside and converted by it into electrical energy. This energy flows back into the intermediate circuit of the frequency converter. This leads to an increase to the intermediate circuit voltage of the frequency converter. Once the intermediate circuit voltage reaches a particular volume, a braking resistor is activated which converts the excess energy into heat.

Operation on the frequency converter (U/f operation)

During U/f operation a frequency converter modifies the motor voltage and the frequency of the motor voltage at a constant ratio. Frequency and voltage are proportional to one another. Due to the inductive behaviour of the motor, this leads to a nearly constant torque across a wide range.

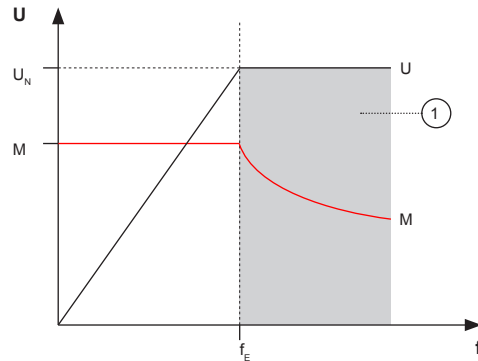

Fig. 30: Ideal voltage/frequency curve

- 1 Field-weakening operation
- M Torque
- f_E Cut-off frequency

This ideal curve shows that the torque remains constant up to the cut-off frequency. If the frequency of the motor voltage reaches the cut-off frequency, the motor voltage has reached its maximum value. If the three-phase current asynchronous motor is operated beyond the cut-off frequency, the magnetisation of the iron core falls and the motor torque drops, too. The motor is in field-weakening range.

At very low frequencies, a voltage proportional to the frequency would lead to a lower torque due to the ohmic resistance of the winding. To compensate for this, a rise in voltage must be set at the bottom frequency range (< 15 Hz). This rise is referred to as $I \times R$ compensation. The illustration below shows the actual U/f curve with a set voltage rise and the resulting torque.

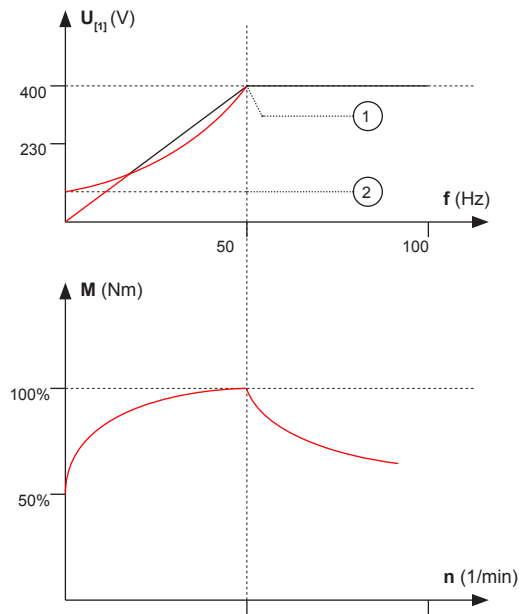

Fig. 31: Real U/f and M/n curves at a frequency of 50 Hz.

- 1 Load balance
- 2 Balance voltage

Operation on the frequency converter (controlled operation)

In controlled operation, the motor is controlled using a vector control. The vector control uses mathematical models for the control of electric motors. The parameters *motor frequency*, *motor current* and *magnetic flow* of the motor are manipulated with suitable control loops with feedback. This method provides much better dynamics, efficiency and torque generation than control using a U/f curve and similar techniques.

The following illustration (Fig. 32) shows the block diagram of a sensor-less vector control. With the vector control, the measured motor currents are split into a flow-forming and current-forming component. These are transferred into a coordinate system which rotates with the frequency of the alternating values (Clarke-Park transformation). If you observe the values within this coordinate system, they lose their sinus-like character. They can be considered equivalent values on which the known processes of the control technology can be used. The flow-forming component (d) is responsible for the magnetic excitation in the motor and thus enables the physical processes which produce the rotary motion in the motor. The active current and thus the torque of the motor are influenced by regulating the torque-forming component (q).



The 8-series frequency converters can regulate the control of the three-phase current asynchronous motors; both sensor-guided and sensor-less.

Block diagram of controlled operation

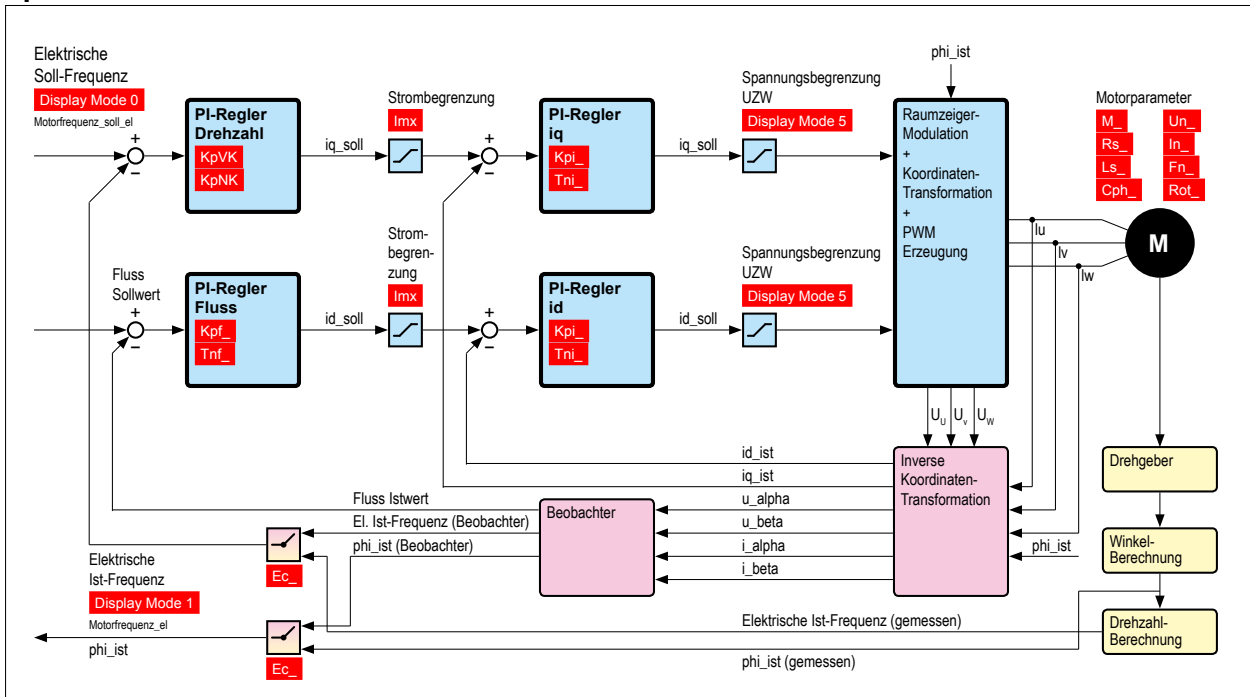

Fig. 32: Block diagram of controlled operation

14.2 Permanent magnet synchronous motor

The permanent magnet synchronous motor (PMSM) is part of the group of synchronous motors. Synchronous motors are characterised in that their rotors rotate at the same speed as the magnetic field which the stator windings produce.

14.2.1 Layout and function

Like the three-phase current asynchronous motor, the permanent magnet synchronous motor consists of a stationary stator and the rotation-mounted rotor.

STB_0004, 10, en_GB

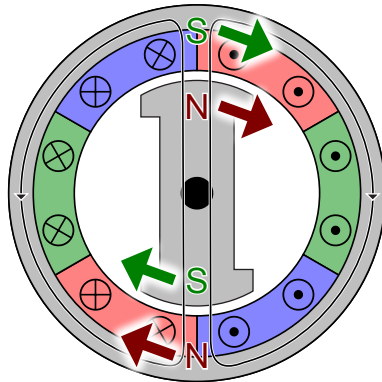

Fig. 33: Permanent magnet with the pole pair number $p = 1$ and 3 phases Source: Wikipedia

Stator

The structure of the stator is similar to the structure of an asynchronous motor with distributed windings.

Rotor

The rotor is the rotating part of the motor which is attached to the motor shaft. In permanent magnet synchronous motors, permanent magnets are located on the rotor.

14.2.2 How it works

If the three windings of a permanent magnet synchronous motor are connected to a symmetrical three-phase mains supply, three 120° -phase-shifted currents of equal frequency and amplitude flow into the windings of the stator. They form a rotating magnetic field. This magnetic field also acts on the permanent magnets of the rotor. The poles of the rotor are pulled by the opposing poles of the field of rotation, and the rotor is placed in a rotary movement. In rated operation, a magnetic bonding exists between the rotary field and rotor field which makes the rotor rotate at the same speed as the field of rotation. In other words, it moves in sync with the rotary field. Provided the rotor and the stator field do not have any relative speed to one another (i.e. they are synchronised), a torque (with an average value not equal to zero) can be formed. The angle between the rotor and stator field determines the level of torque.

Idle operation (polar wheel angle = 0°)

If a permanent magnet synchronous motor is operated in idle, then the poles of the rotor are exactly opposite the poles of the rotary field. In idle, there is no offset between the field of rotation and the rotor. The torque of the motor is equal to zero. The tightening force between the rotary field pole and the rotor pole may be at the maximum, but no effective moment arm is produced.

Operation with load (polar wheel angle 0–90°)

With a load the distance between the rotor poles and the rotary field poles increases and the tightening torque between the poles decreases. The rotor stays lags the idle position by the pole wheel angle h , yet it still turns at the rotary field speed. When the distance is increased, the effective moment arm simultaneously becomes greater. At a polar wheel angle of 90°, the torque reaches its maximum, because here the leading opposite pole has a pulling effect and, at the same time, the following pole of the same name has a pushing effect. The maximum value of the torque is referred to as the tilting torque M_K .

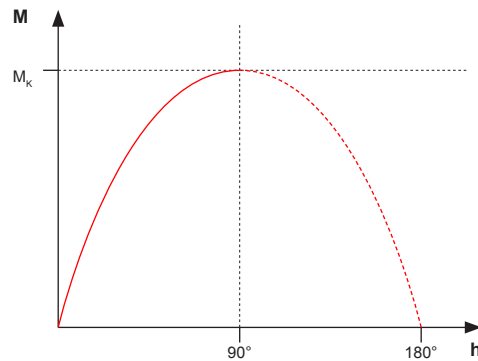

Fig. 34: Polar wheel angle

Overload operation (polar wheel angle > 90°)

If the maximum value of the torque is exceeded, the field of rotation and the magnetic field of the stator magnets lose their magnetic bonding. The synchronicity disappears and the motor falls out of step.

If the motor falls out of step, there is different behaviour for U/f operation and controlled operation.

In U/f operation, the motor will always try to synchronise itself; in other words, it makes short jumps in speed and drops back to a standstill if it does not succeed. The current will increase and fluctuate. Faults may be triggered.

In controlled operation, there will be high noise emissions from the current control loop, because the controller cannot re-establish synchronicity. Excess current faults may be triggered.

Operation on the frequency converter

The torque of a PMSM behaves proportionally to the motor current; its speed proportional to the infeed frequency. At a rated torque (1) and speed (2), a particular voltage is required.

If the frequency converter can supply a higher voltage, the speed can be increased further (7). This leads to a higher power at a constant torque. If the voltage has reached an upper limit, the motor crosses over into the field-weakening range (88).

If the motor mechanics and insulation can support the higher speed and the higher voltage, operation in the field-weakening range with series-8 converters is possible. Information on this is in the parameter settings of the relevant control system.

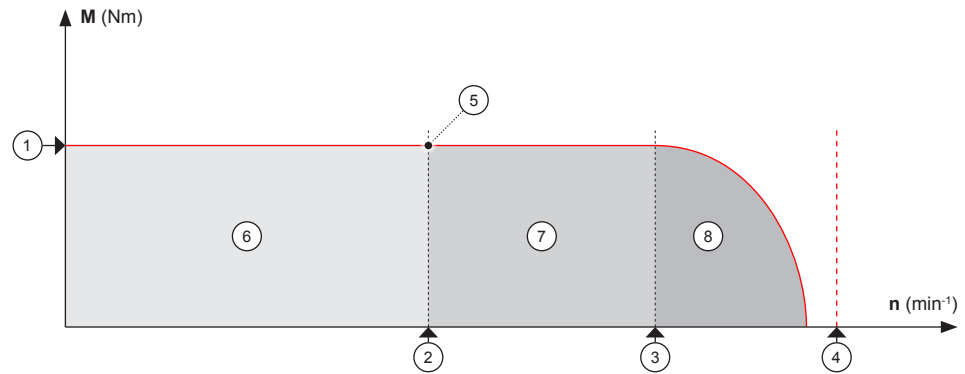

Fig. 35: How it works

- 1 Rated torque
- 2 Rated speed
- 3 In reference to counter EMK
- 4 Critical speed
- 5 Rated power
- 6 Rated speed range
- 7 Above rated speed
- 8 Field weakening

Another option for expanding the speed range is to change the star circuit of a motor into a delta one, providing the motor allows this. Similarly to asynchronous motors, a delta circuit also leads to a higher voltage on the windings since it is not reduced by a factor of 1.73 or $\sqrt{3}$, as is the case with the star circuit.



The 8-series frequency converters can regulate the control of the permanent magnet synchronous motors; both sensor-guided and sensor-less.

14.2.3 Parameters for the settings of the controlled operation

The parameters which have a significant influence on the behaviour of the frequency converter and the motor in uncontrolled operation are:

Drive

M_	Motor - Type
In_	Motor - Rated current
Un_	Motor - Rated voltage

Drive

Cph_	Cos ϕ
Rot_	Motor - Rated speed
Rs_	Motor - Stator resistance
Ls_	Motor - Stator inductance
Imx_	Motor - Maximum current
TIm_	Time until motor current fault is reported
Tra_	Gear ratio
Dia_	Wheel diameter

Motion

Fn_0	Normal movement - Cut-off frequency
IR_0	Normal movement - I×R compensation
Fn_1	Ascent - Cut-off frequency
IR_1	Ascent - I×R compensation factor
Fn_2	Descent - cut-off frequency
IR_2	Descent - I×R compensation factor
Fn_3	Synchronous movement - Cut-off frequency
IR_3	Synchronous movement - I×R compensation factor
Fn_4	Special movement - Cut-off frequency
IR_4	Special movement - I×R compensation factor
IF1	Factor for current value in I/F mode

14.2.4 Parameters for the settings of controlled operation (vector control)

The parameters which have a significant influence on the behaviour of the frequency converter and the motor in controlled operation are:

- All parameters for uncontrolled operation
- Following table

Motion

Kpf_	Flow regulator proportional gain
Tnf_	Flow regulator integral time
KpVK	Speed regulator proportional gain, pre-decimal point
KpNK	Speed regulator proportional gain, post-decimal point
Tnd_	Speed regulator integral time

Motion

Kpi_	Current regulator proportional gain
Tni_	Current regulator integral time

14.3 Brushless DC motors

Despite their name, Brushless DC motors (BLDC) do not belong to DC motors but to the three-phase current synchronous motors.

14.3.1 Layout and function

The structure and function of a BLDC motor is equivalent to a permanent magnet synchronous motor.

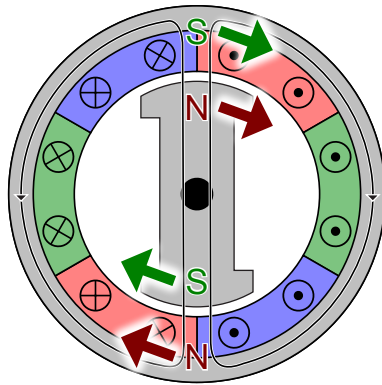

Fig. 36: BLDC motor Source: Wikipedia

The rotor follows a magnetic field of rotation. The movement is synchronous with the AC voltage applied to the windings.



The 8-series frequency converters can regulate the control of the BLDC motors; both sensor-guided and sensor-less. For motor commutation they use sinusoidal commutation.

14.4 Frequency converters

When connecting a motor directly to the mains supply, ideal operating conditions arise at the rated operating point. However, a frequency converter guarantees excellent operating conditions across the entire operating range by adapting its output values (voltage, frequency) to the current load conditions.

A frequency converter allows speed and torque to be adjusted to a powered machine and maintained. The basic functions can be summarised as follows:

- Turning and positioning the rotor
- Speed regulation with and without feedback from the three-phase motor
- Torque regulation with and without feedback from the three-phase motor
- Monitoring and signalling operating conditions

14.4.1 Layout and function

The frequency converter converts the sinusoidal AC voltage of the feeding electricity network into an AC voltage of alternating frequency and amplitude. Frequency and amplitude serve as manipulated variables for the connected motors.

Frequency converters with intermediate circuits consist of four main components:

- Rectifier
- Intermediate circuit
- Inverter
- Control circuit

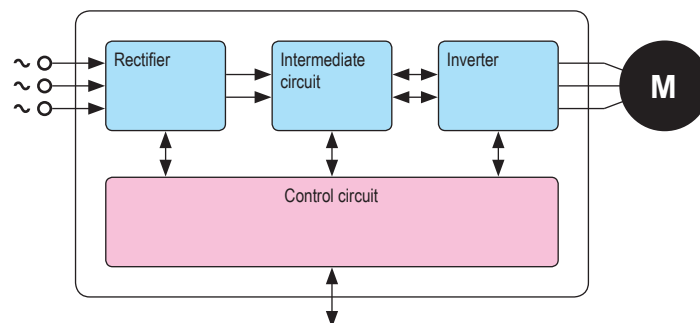

Fig. 37: Block diagram of a frequency converter and intermediate circuit

14.4.2 Rectifier

The supply voltage is a three-phase AC voltage with a fixed frequency (e.g. $3 \times 400 \text{ V} / 50 \text{ Hz}$). The rectifier is connected to this supply voltage and generates a pulsating DC voltage.

14.4.3 Intermediate circuit

The task of the intermediate circuit is to:

- Smoothing the pulsating DC voltage of the rectifier
- Power reserve in case of voltage supply loss

- Energy storage for load surges and generator operation of the motor
- Reducing mains faults

Electrolytic capacitors are used for energy storage. In idle, the intermediate circuit voltage is typically $\sqrt{2} \times \text{mains voltage}$. When a motor is under load, the voltage drops; and in generator mode, the motor feeds electrical power back into the intermediate circuit, whereby voltage increases. Once the voltage reaches a particular threshold, a braking resistor is activated which converts the excess energy into heat. If the voltage continues to increase, the frequency converter shuts down with a fault to prevent destruction.

14.4.4 Inverter

The output voltage and the output frequency are adjusted in the inverter. The inverter has the task of converting the commutated mains voltage back into an alternating value for supply to the motor.

The main components of the inverter are six IGBTs which are arranged in pairs on three branches (U, V, W). They are used to vary the duration of time the intermediate circuit voltage is connected to the motor windings. The frequency also varies through the shifting of positive and negative voltage pulses during the two half periods along the time axis.

As this technology modifies the width of the voltage pulses, this process is referred to as PWM: Pulse-Width Modulation. With PWM technology, the control circuit controls the activation and deactivation of the semiconductor so that the motor voltage course is as sinusoidal as possible across the inductances of the motor. This means the losses in the motor windings are reduced and a gentle motor operation can be reached even at low speeds.

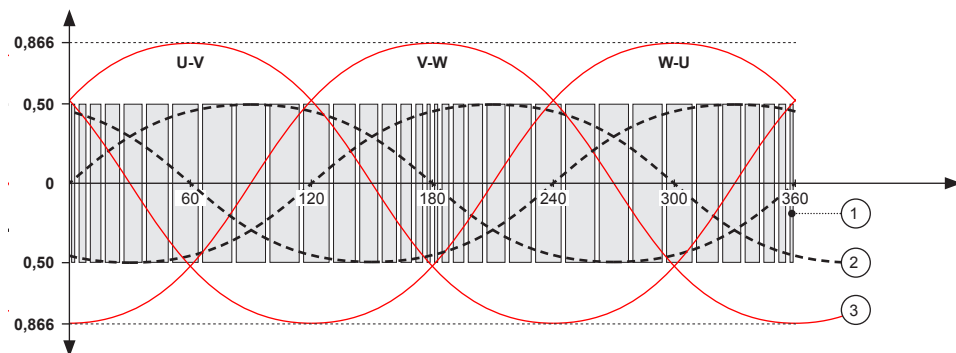

Fig. 38: PWM output voltage

- 1 PWM signal
- 2 Phase voltage (phase star point)
- 3 Chained voltage

14.4.5 Control circuit

The control circuit is the fourth main element of the frequency converter. It generally has four main tasks:

- Controlling the semiconductor in the frequency converter
- Exchanging data with the main CPU
- Measuring, detecting and issuing faults and warnings
- Protective functions for the frequency converter and motor

The software of the frequency converter offers three different types of control:

- U/f curve
- Vector-based control without feedback
- Vector-based control with feedback

14.4.6 ST-87x/88x Current Monitor

The current monitor of the converter is composed of three components.

- 1 - Short circuit monitor with immediate shutdown of the PWM signals.
- 2 - I^2t -monitors for the motor and the frequency converter whose parameters can be assigned separately.
- 3 - Software-based shutdown of the frequency converter if excess current is detected.

14.4.6.1 Hardware short circuit shutdown

The short circuit signal is developed from the hardware. In this process, the three motor phases and the brake resistor are monitored. The short circuit signal is carried on a special hardware unit (trip zones) of the microcontroller. In the microcontroller this signal travels independently of the software to switch off the PWM signals and the brake resistor. The brake is immediately locked and the fault $[F011]$ is output.

There is no parameter assignment for the short circuit detection.

As the short circuit signal for low voltages cannot be generated reliably, the frequency converter is immediately shut down at intermediate voltages of below 450 VDC. The PWM signals are switched off and the brake is locked.

14.4.6.2 I^2t -monitor (maximum load integral)

The I^2t -monitor is a monitor of the current energy volume.

As the energy cannot be measured directly, the product is monitored using RMS and time. The product is proportional to the volume of energy.

Calculate I²t limit

There are two current limits:

- i_{cont} – Continuous current limit
- i_{max} – Maximum current limit

In addition to this there is the maximum time " t_{max} " at which " i_{max} " may be present.

From this the I²t limit can be calculated:

$$I^2t_{lim} = (i_{max}^2 - i_{cont}^2) * t_{max}$$

I²t_{lim}

I²t_{lim} represents the maximum limit.

It can reach the I²t-value without a fault being triggered.

Running operation

In live operation, the following I²t-values are summed up in every scanning step:

$$I^2t_{current} = I^2t_{current_old} + (i_{eff}^2 - i_{cont}^2) * t_{scan}$$

- t_{scan} - Duration of the scanning step
- i_{eff} - Current RMS

If I²t_{current} is greater than I²t_{lim}, a fault is triggered.

The following formula specifies the maximum time in which a special current value can be present before a fault is triggered.

$$t_{fault} = I^2t_{lim} / (i_{eff}^2 - i_{cont}^2)$$

Example

$$i_{max} = 10 \text{ A}$$

$$i_{cont} = 5 \text{ A}$$

$$t_{max} = 1 \text{ s (maximum time for } i_{max})$$

$$i_{eff} = 8 \text{ A (current motor current)}$$

$$I^2t_{lim} = ((10 \text{ A})^2 - (5 \text{ A})^2) * 1 \text{ s} = 75 \text{ A}^2\text{s}$$

$$t_{fault} = 75 \text{ A}^2\text{s} / ((8 \text{ A})^2 - (5 \text{ A})^2) = 1.92 \text{ s}$$

For $i_{eff} = 10 \text{ A}$ would result in $t_{fault} = t_{max} = 1 \text{ s}$.

14.4.6.2.1 Motor I²t-monitor

The following motor parameters are relevant:

- $[In]$ (nominal motor current)
- $[Imx]$ (maximum current)
- $[TIm]$ (time to excess current)

From this the following values for the I²t monitor are calculated:

$$i_cont = I_{n_} + (I_{mx_} - I_{n_})/2$$

$$i_max = I_{mx_}$$

$$t_max = T_{Im_}$$

In the event of an error, fault [F115] (excess motor current) is output and the drive is powered down to the highest deceleration ramp before stopping.

14.4.6.2.2 Frequency converter I²t-monitor

$$i_cont = i_converter \text{ class}$$

$$i_max = 12.8 \text{ A}$$

$$t_max = 1 \text{ s}$$

In the event of an error, fault [F118] (excess converter current) is output and the drive is powered down to the highest deceleration ramp before stopping.

14.4.6.3 Software-based shutdown in the event of excess current

If the effective current of the converter exceeds 20 A for 100 ms, the converter is powered down to the highest deceleration ramp before stopping with fault [F018] (current).

15 Customer service and addresses

Customer service

Our service team is available to provide technical information.

- **Conductix-Wampfler Automation - Service**

Phone: +49 331 887344-15 | Fax: +49 331 887344-19

E-mail: service.potsdam@conductix.com



Service forms

Service forms are available for download under www.conductix.com.

Please send completed service forms to service.potsdam@conductix.com.

Further contacts

Conductix-Wampfler Automation GmbH

Handelshof 16 A | 14478 Potsdam | Germany

Phone: +49 331 887344-0 | Fax: +49 331 887344-19

E-mail: info.potsdam@conductix.com | Internet: www.conductix.com

- **Conductix-Wampfler Automation - Sales**

Phone: +49 331 887344-02 / -04 | Fax: +49 331 887344-19

E-mail: sales.potsdam@conductix.com

- **Conductix-Wampfler Automation - Service**

Phone: +49 331 887344-15 | Fax: +49 331 887344-19

E-mail: service.potsdam@conductix.com

- **Conductix-Wampfler Automation - Repairs**

Phone: +49 331 887344-615 | Fax: +49 331 887344-19

E-mail: repair.potsdam@conductix.com

Conductix-Wampfler GmbH

Rheinstrasse 27 + 33 | 79576 Weil am Rhein | Germany

Phone: +49 7621 662-0 | Fax: +49 7621 662-144

E-mail: info.de@conductix.com | Internet: www.conductix.com

For further addresses of sales and service locations, visit:

- www.conductix.com

16 Index

A

Active error number.....	138
Actual distance (distance control).....	136
Actual distance (safe stop).....	137
Actual electrical frequency.....	122
Actual speed.....	122
Acyclic telegram – Index	
Diagnostics 1.....	98
Diagnostics 1 reset.....	99
Diagnostics 2.....	99
Error log.....	99
Error reset.....	98
Target index / position.....	100
Vehicle-related data.....	100
Vehicle type.....	98
Acyclic telegrams	
Change table.....	100
Addresses.....	183
Applicable documents.....	10
Attachment bracket.....	40, 41
Automatic mode.....	112

B

B6 rectifier.....	47
Bus communication.....	95
Bus time-out.....	138
BV.....	139

C

Cable routing.....	50
Capacitive load.....	52
Capacitive loads.....	52
Certifications.....	165
Charging/discharging current.....	48
Circuit breakers.....	46
Cleaning.....	154
Compensation.....	29
Configuration switch.....	77, 78, 79
Conformity.....	165

Control word.....	122
Converter position.....	127
Cooling.....	34, 35
CPU temperature.....	122
Current distance encoder value.....	130
Current limit	
Continuous.....	180
Maximum.....	180
Current monitor.....	179
Current parameter sets Motor and Motion.....	127
Customer service.....	183
D	
Damage in transit.....	29
DC link voltage.....	122, 179
Debug area.....	139
Debug pages.....	139
Design.....	27
Destination index.....	137
Dimensions.....	159
Display.....	36
Extended.....	117
Fault indicator.....	117, 147
Infra-red communication.....	117
Standard.....	116
Display mode	
000.....	122
001.....	122
002.....	122
003.....	122
004.....	122
005.....	122
006.....	122
007.....	122
008.....	122
009.....	124
010.....	124
011.....	124

013.....	125	102.....	134
014.....	126	103.....	134
015.....	127	104.....	134
018.....	127	105.....	134
020.....	127	106.....	134
025.....	127	107.....	134
026.....	128	108.....	134
027.....	129	109.....	134
028.....	129	111.....	134
029.....	129	117.....	135
030.....	129	118.....	135
032.....	129	120.....	136
035.....	130	121.....	136
036.....	130	130.....	136
037.....	130	131.....	136
038.....	130	140.....	136
039.....	130	141.....	136
040.....	130	142.....	137
041.....	131	143.....	137
050.....	131	144.....	137
051.....	133	145.....	137
053.....	133	146.....	137
054.....	133	147.....	137
055.....	133	150.....	138
057.....	133	152.....	138
060.....	134	153.....	138
080.....	134	160.....	138
081.....	134	170.....	138
090.....	134	171.....	138
091.....	134	172.....	138
092.....	134	173.....	138
093.....	134	174.....	138
094.....	134	175.....	138
095.....	134	176.....	138
096.....	134	177.....	138
097.....	134	178.....	138
098.....	134	179.....	138
099.....	134	180.....	138
100.....	134	181.....	138

182.....	138	G	
183.....	138	GET.....	133
200-219.....	139	Grid feed.....	53
235.....	139	H	
236.....	139	Heat sink.....	27, 35
237.....	139	Heat sink temperature.....	129
238.....	139	Hidden components.....	129
239.....	139	Housing.....	27
250-253.....	139	I	
Distance encoder distance index.....	130	I/O card inputs.....	130
Distance reference.....	136	I/O card outputs.....	131
Distance table.....	85, 91	I ² t limit.....	180
E		I ² t-monitor.....	179, 180, 181
Earth.....	50	IGBT pulse inverter.....	47
Electromagnetic interference.....	47	Incoming SSU function.....	135
EMC directive.....	48	Infra-red reception.....	36
EMC product standard.....	48	Input data	
EMC requirements.....	48	Digital inputs.....	162
EN 61800-5-1.....	23	Half-wave input.....	161, 162
Encoder position - filtered.....	130	Input data.....	161
Encoder position - unfiltered.....	130	Power supply.....	161
Entries of the segment table for the current system segment.....	138	Quadrature inputs.....	162
Environmental conditions.....	160	Z-stop.....	162
Error index - Converter parameters.....	138	Installation.....	39, 40
Error status - CAN bus.....	138	Installation position.....	36
Error word 0.....	125	Intended use.....	16
Error word 1.....	126	Interface	
Error word 2.....	127	Infra-red.....	164
Error word parameter identification.....	129	Rail bus.....	164
F		RS485.....	164
Fault reset.....	150	SPI encoder.....	164
Faults to be acknowledged.....	149	Intermediate voltage circuit.....	47
Fault types.....	149	Internal command.....	134
FCS block.....	134	Internal commands.....	128
Fixing.....	37, 39, 40	Inverter status.....	124
Functionality.....	25	IR command.....	133
Fuse types.....	46	L	
		Leakage current.....	47, 50
		LEDs.....	114

Line filter.....	47	X13.....	60
Line protection types.....	46	X14.....	61
M		X15.....	61
Mains fuse.....	46	X16.....	62
Maintenance.....	19, 153	X17.....	63
Manual mode.....	112	X2.....	58
Manual reset.....	150	X30.....	64
Material.....	159	PLC command A+B.....	136
Model name.....	25	PLC status A+B.....	136
Motor current.....	129	Position encoder status.....	130
Motor power.....	122	Power class.....	25
Motor temperature.....	122	Power on Reset.....	151
Motor voltage.....	129	Protective earthing.....	53
Movement enabling.....	127	Q	
N		Qualification.....	18
Number of motor pole pairs.....	133	R	
O		Relay status notification.....	133
Open path (DKZ / TCU).....	137	Remote control.....	142
Open path sent to converter.....	137	Residual current.....	46
Operating temperature.....	34	Residual current circuit breaker (RCCD)....	46
Operation.....	19, 153	Responsibility of the operator.....	17
Outgoing SSU function.....	135	Responsible party	
Output data		Commissioning.....	67
Axis data.....	162	Electrical installation.....	43
Brake resistor.....	162	Installation.....	31
Digital outputs.....	163	Operation.....	109
On resistance.....	162	RMS.....	180
Signal output.....	163	S	
P		Safe isolation.....	23
Parameter.....	78	Safety	
Parameter values.....	70, 77	Operation.....	109
PCM command.....	80, 131	Safety notes.....	13
PCM configuration table.....	80	Scanning step.....	180
PE connection.....	53, 65	Segment table.....	88
Personnel.....	18	Self-acknowledging faults.....	149
Pin configuration		Self-reset.....	151
X1.....	57	Set speed.....	122
X10 BLDC motor.....	59	Short circuit shutdown.....	179
X10 brake resistor.....	60	Short circuit signal.....	179

Speed table.....	85, 90	X30.....	56, 64
Start delay.....	73, 113, 116	Z	
Status LEDs.....	114	Z-stop.....	133
Stop-offset table.....	92		
Stopping distance from actual speed.....	124		
Stopping distance from set speed.....	124		
Storage.....	30		
Switches the control system off.....	113		
Switch on control system.....	73, 112		
T			
Table test.....	134		
Target electrical frequency.....	122		
Target position.....	137		
Transfer of risk.....	70		
Transport.....	29		
Trip zones.....	179		
Type label.....	26		
U			
Unrestrained manual mode.....	112		
USB connection.....	64		
V			
Valid path.....	136		
Vehicle number.....	134		
Vehicle parameters.....	79		
Vehicle table.....	80, 88		
Vehicle tables.....	86, 87, 93, 94		
Vehicle type.....	134		
W			
Warranty.....	11		
Weight.....	160		
X			
X1.....	56, 57		
X10.....	56, 59, 60		
X13.....	56, 60		
X14.....	56, 61		
X15.....	56, 61		
X16.....	56, 62		
X17.....	56, 63		
X2.....	56, 58		